



I-PAC inverter heat pumps

I-PAC 50/100BLY, I-PAC 50/100BHC

Owner Installation Manual 1007929 Issue 1



HEALTH AND SAFETY WARNING

This product contains electrical and rotational equipment and must be isolated electrically before removing access panels. ONLY competent trained people should work on this device.

This appliance can be used by children from 8 years and above and persons with reduced physical, sensory or mental capabilities or lack of experience and knowledge if they have been given supervision or instruction concerning use of the appliance in a safe way and understand the hazards involved. Children should not play with the appliance. Cleaning and user maintenance shall not be made by children without supervision.



CONTENTS

HEALTH AND SAFETY WARNING	2	4.0 USING YOUR HEAT PUMP.....	21
1.0 INTRODUCTION	4	4.1 THE KEY PAD	21
1.1 FOREWORD	4	4.2 OPERATING INSTRUCTIONS.....	22
1.2 WARNINGS	4	4.3 USING THE APP	23
2.0 ABOUT YOUR HEAT PUMP	7	4.4 USING THE OPTIONAL REMOTE CONTROLLER	29
2.1 TRANSPORTATION	7	4.5 THE KEY PAD	29
2.2 ACCESSORIES.....	8	4.6 OPERATING INSTRUCTIONS.....	30
2.3 OPTIONAL ACCESSORIES.....	8	5.0 TESTING	31
2.4 FEATURES.....	9	5.1 HEAT PUMP MALFUNCTION	31
2.5 OPERATING CONDITIONS AND RANGE	9	5.2 PROTECTION CODES	32
2.6 OPERATING MODES	9	5.3 FAULT CODES.....	33
3.0 INSTALLATION	10	6.0 MAINTENANCE	34
3.1 POSITIONING AND AIRFLOW	10	7.0 TROUBLE SHOOTING COMMON FAULTS	34
3.2 POOL WATER CIRCUIT.....	13	8.0 I-PAC 50/100BLY, I-PAC 50/100BHC DATASHEET	35
3.3 PLUMBING.....	14	9.0 I-PAC 50/100BLY, PERFORMANCE GRAPHS 	36
3.4 INITIAL CHECKS	14	10.0 PRODUCT DRAWINGS	37
3.5 ELECTROLYTIC CORROSION IN SWIMMING POOLS.....	15	11.0 WINTERISATION PROCEDURE	41
3.6 ELECTRIC WIRING AND SUPPLY	15	11.1 START UP PROCEDURE AFTER WINTERISATION	41
3.7 CONNECTING THE HEAT PUMP TO THE POWER SUPPLY	16	12.0 WARRANTY CONDITIONS.....	42
3.8 POOL PUMP SYNCHRONISATION TERMINALS P1 AND P2.....	18	13.0 HEAT PUMP RECORD LOG.....	43
3.9 INSTALLING THE OPTIONAL REMOTE CONTROLLER	19	14.0 DECLARATION OF CONFORMITY	45
3.10 REMOTE ON / OFF TERMINALS 5 AND 6 	20		

1.0 INTRODUCTION

1.1 FOREWORD

Thank you for choosing this product, which is designed for quiet and energy efficient operation. It is the ideal way to heat your pool in an environmentally friendly way.

This guide provides information needed to install and operate the heat pump effectively. Please ensure you read this manual and use the correct installation and operating procedures.

This manual is intended for installers and users. Read the entire manual before using the heat pump. Awareness of the correct operating procedure for the machine and any safety devices is important, to avoid damage or injury.

The appliance can be used by children aged from 8 years and above and persons with reduced, physical, sensory or mental capabilities or lack of experience and knowledge if they have been given supervision or instruction concerning use of the appliance in a safe way and understand the hazards involved. Children shall not play with the appliance. Cleaning and user maintenance shall not be made by children without supervision.

1.2 WARNINGS

Important safety information is contained in this manual and marked on the heat pump.

Please read and follow all safety advice.



The WARNING sign denotes a hazard. It calls attention to a procedure or practice, which if not adhered to could result in injury. Warning signs and procedures must be complied with.

If a refrigerant leak is suspected stop using the heat pump and contact Dantherm Group UK service.

service.department@dantherm.com or +44(0)1621 856611 (option 4).

Take the following precautions in order to avoid any danger:

REFRIGERANT SAFETY:

Repair, service and disposal must be carried out by F-Gas registered engineers.

Completely evacuate the refrigerant before any brazing is performed. Brazing can only be carried out by technicians trained to EU 517/2014.

Risk assessments must be carried out before maintenance or repairs are started.

Appropriate safety measures and risk assessments must be taken before work commences.

Do not attempt to work on the equipment by yourself.

Consult the qualified engineer undertaking the work to establish all requirements before work commences.

ACTIONS TO AVOID (OPERATION AND HANDLING):

Be especially careful when handling the heat pump, not to cause any damage that may result in leakage of the cooling circuit.

Do not use means to accelerate the defrosting process or to clean, other than those recommended by the manufacturer.

Do not pierce or burn.

IN CASE OF FIRE:

Toxic fumes may occur in the event of fire. You must leave the room as quickly as possible in the event of fire.

Check if there are any local regulations, which you must comply to, when installing or storing the heat pump.

Be aware that refrigerants may not contain an odour.

OWNER/INSTALLATION MANUAL

Installation must be carried out by competent people, in accordance with this manual.

INSTALLATION:

Read the instructions before installation, use and maintenance.

If a repair is required, please contact the nearest after-sales service centre.

To avoid over heating or over cooling of pool water check and set the temperature on the control panel.

The performance can be improved by insulating the flow and return pipework.

It is recommended that a cover is used on the swimming pool to reduce heat losses.

AIRFLOW:

The heat pump must have access to adequate airflow. See section 3.1.

Do not place obstructions that will block air flow near the inlet or outlet.

ELECTRICAL SAFETY:

Mains power isolator should be out of reach of children.

After a power cut, when the power supply is restored, the heat pump may start up without warning.

Electric storms can damage electronic equipment. Ideally the heat pump should be switched off at the mains.

HEAT PUMP MALFUNCTION:

WARNING: Isolate heat pump electrically and wait 3 minutes before removing panels or entering heat pump.

Refer to the user check list in section 5.2 and the error codes listed in section 5.3 before initiating a service call.

Do not attempt to interfere with any internal control settings as these have been factory calibrated and sealed.

Any sign of abnormal operation such as water dripping should be reported immediately to the installer. If in doubt or if advice is required contact the Service support team on telephone +44(0)1621 8566 11 (option 4).

MAINTENANCE:

Isolate the power supply of the heat pump and wait 3 minutes before cleaning examination or repair.

Please clean this machine with household detergents or clean water. NEVER use petroleum spirit, thinners or any similar fuel.

Check bolts, cables and connections regularly.

BACKWASH:

When performing a routine backwash care should be taken to prevent water passing through the heat pump in the reverse direction or at a rate which exceeds the maximum recommended water flow rates indicated in the data sheet [section 8] as this may cause damage to the heat pump water condenser or flow switch.

DISPOSAL:

Repair, service and disposal of redundant heat pumps must be completed by authorised technicians. It is illegal to allow refrigerant gases to escape to air.

Do not attempt to work on the equipment by yourself. Improper operation may cause danger.

2.0 ABOUT YOUR HEAT PUMP

2.1 TRANSPORTATION

Always keep the heat pump upright.

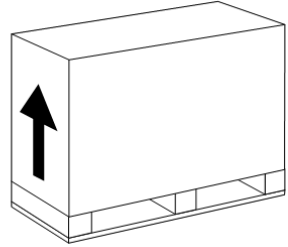

Undo the fixing screws on the pallet.

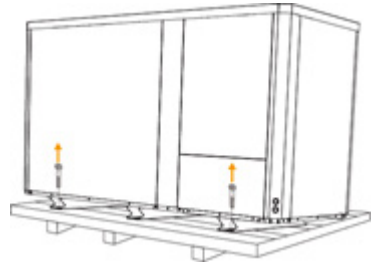

Use a forklift to move the heat pump to the location.



Do not lift the heat pump by the water inlet or outlet connections.

(If this is done the titanium heat exchanger inside the heat pump could be damaged).

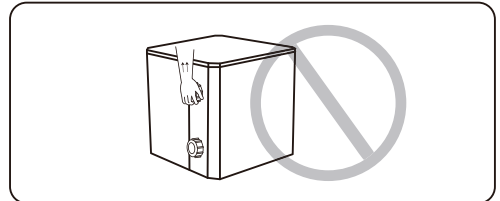

2.2 ACCESSORIES

These accessories are provided with the heat pump.

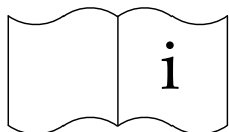

2.3 OPTIONAL ACCESSORIES

The following items are additional accessories available for purchase.

Remote controller kit for indoor installation.

(10m extension cable).

Supplied with a module to allow the Wi-Fi connectivity function to operate with the remote control.



2.4 FEATURES

- Stepless DC inverter compressor
- Brushless fan motor
- EEV Technology (Electronic Equalisation Valve)
- Reverse cycle defrosting with 4-way valve
- High-efficiency twisted titanium heat exchanger
- High pressure and low pressure protection
- Soft start and wide voltage application
- Stable inverter control system

2.5 OPERATING CONDITIONS AND RANGE

Air temperature operating range:

I-PAC 50 / 100BLY models: -7°C to 43°C

I-PAC 50 / 100BHC models: 10°C to 55°C



Water temperature setting range:

Heating: 18°C-35°C

Cooling: 12°C-30°C

2.6 OPERATING MODES

The heat pump has two modes: Boost mode and Whisper mode.

Mode	Modes	Characteristics
	Boost mode	Heating capacity: 20% to 100% capacity Intelligent optimization Fastest heating
	Whisper mode	Heating capacity: 20% to 80% capacity Sound level: 3dB(A) lower than Boost mode

3.0 INSTALLATION

Installation must only be attempted by competent personnel.

3.1 POSITIONING AND AIRFLOW



The heat pump should be located in an open space with the maximum possible distance in all directions to any obstructions. The heat pump should not be covered by any structure or awning.

The heat pump works by absorbing energy from air passing through it so any restriction in the air flow will reduce performance.

An obstruction is an object such as a wall, fence, hedge or anything similar which may restrict the free movement of air.

Obstructions can also cause exhaust air leaving the heat pump to be sucked back into the heat pump which will reduce performance.

Locating the heat pump near any obstructions should be avoided if possible however if it is enclosed on up to two sides by obstructions at the minimum distances then the heat pump should perform as expected.

If the heat pump is enclosed on more than two sides by obstructions at the minimum distances then the performance will be reduced.

If there are obstructions closer to the heat pump than the minimum distances then the performance will be significantly reduced.

A reduction in performance will result in longer pool heat up times, the pool not reaching the desired temperature and excess energy costs.

The diagrams show the minimum allowable mandatory distances between the heat pump and any potential obstructions.

The heat pump should be fixed by M10 bolts to a level concrete base or to solid mounting brackets which are securely fixed. Fixings [including any brackets] must be corrosion proof. Ensure the condensate connection is made prior to securing the heat pump.

Airflow – general principles

- The heat pump absorbs energy from the air drawn through it. To function effectively the heat pump must have access to the fresh air it needs.
- Air must not recirculate. The air leaving the heat pump must not be sucked back into the inlet.
- Air must not be restricted. The air volume must not be reduced.
- The minimum required distances shown must be provided to minimise the risk of air recirculation or restriction and reduction in performance. Examples are shown on the following page.

I-PAC 50BLY / I-PAC 50BHC

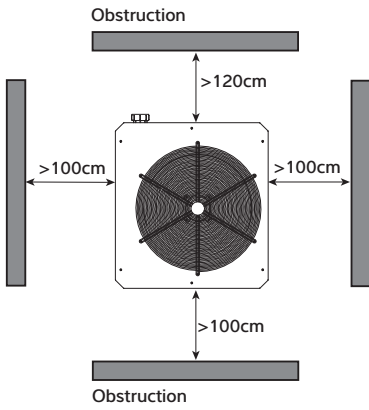

I-PAC 100BLY / I-PAC 100BHC

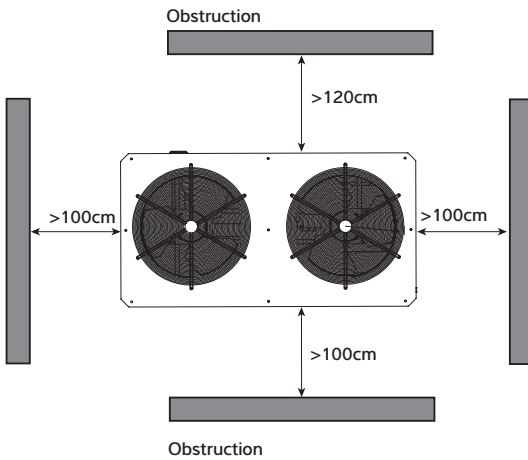

OWNER/INSTALLATION MANUAL

To comply with safety regulations regarding electrical installations in wet areas the heat pump must be installed at least 350cm away from the edge of the pool or spa.

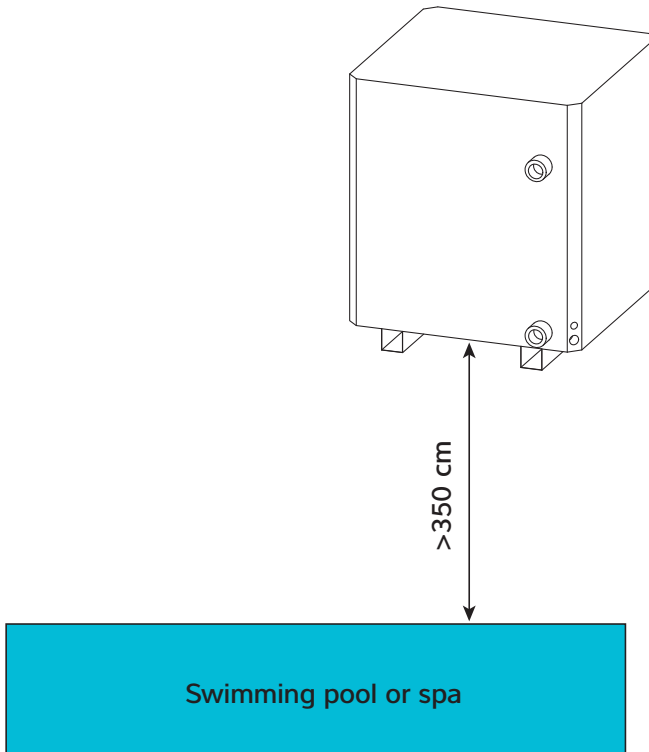

3.2 POOL WATER CIRCUIT

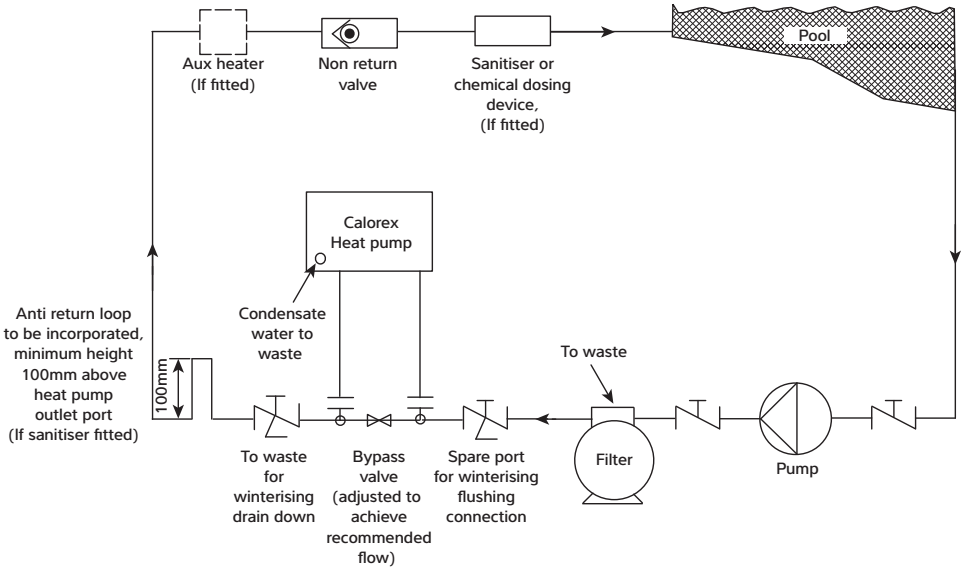

KEY	
Isolation valve	
Breakable coupling	
Three way valve	

3.3 PLUMBING

IMPORTANT

Before installing the heat pump ensure the blanking disks are removed from the pool water in/out connections. These should drop out when the adaptors are unscrewed.

1. Ensure that bypass is installed and set to achieve the recommended flow rates stated in the data sheet.
2. Ensure that the condensate drain kit supplied is fixed and is drained to a drain or soak-away.
(It is best to do this first before the heat pump is fixed to pipework or the ground).
3. Inlet and outlet pipework must be supported to avoid excessive strain on the connections.
4. Water quality must be maintained. See warranty conditions.

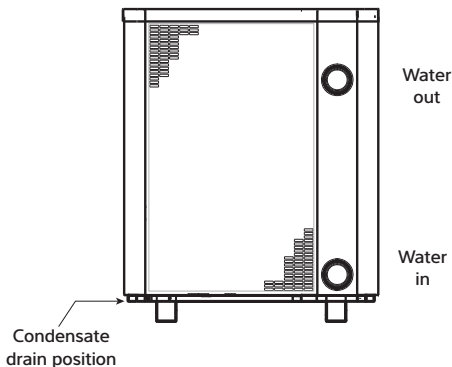
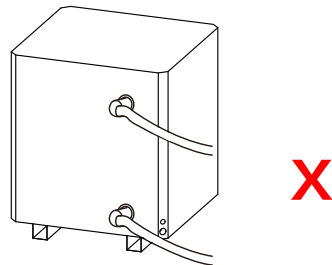
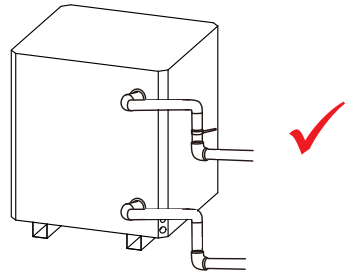

3.4 INITIAL CHECKS

Start the filtration pump before the heat pump is turned on, and turn off the heat pump before the filtration pump. It is recommended to turn off the heat pump prior to backwashing.

Before starting the heat pump, please check for any leakage of water; and check/set the required temperature on the controller, and then turn on.

In order to protect the components, the heat pump incorporates time delays. When starting heating/cooling the fan will run for one minute before the compressor starts. When the heat pump stops heating/cooling, or is turned off by the user, the fan will continue to run for one minute.

After starting up, check for any error codes or abnormal noise from the heat pump.

3.5 ELECTROLYTIC CORROSION IN SWIMMING POOLS

Electrolytic corrosion will occur when dissimilar metals that are in contact with each other create a potential difference between themselves. Sometimes separated by a conductive substance known as an electrolyte, the dissimilar metals will create a small voltage (potential difference) that allows the ions of one material to pass to the other.

Just like a battery, ions will pass from the most positive material to the more negative material.

Anything more than 0.3 volts can cause the most positive material to degrade.

A swimming pool with its associated equipment can create this effect. The pool water being an ideal electrolyte and components of the filtration circuit, heating system, steps, lights etc providing the dissimilar metals needed to complete the circuit.

Whilst these small voltages are rarely a safety threat, they can create premature failure through corrosion. Not dissimilar to corrosion through oxidation, electrolytic corrosion can cause complete failure of a metallic material in a very short period of time.

In order to prevent this type of corrosion all metallic components in contact with swimming pool water should be bonded together using 10mm² bonding cable. This includes non-electrical items such as metal filters, pump strainer boxes, heat exchangers, steps and handrails. It is highly recommended that bonding be retrofitted to existing pools, which may not be protected by this system.

3.6 ELECTRIC WIRING AND SUPPLY

All electrical work to be carried out in accordance with I.E.E. regulations, latest issue, or local codes of practice as applicable.

The machine should be installed in accordance with EMC2004/108/EC.

Always isolate the main power supply before removing machine covers.

The machine power supply must incorporate the following. Fuses or motor type circuit breakers (aM Fuse / MCB type C) to specified rating (see datasheet). When using a fuse, H.R.C. fuses are recommended. An isolator which disconnects all poles must be fitted within 2m and in line of sight of the heat pump. The isolator must have a minimum of 3mm air gap when turned off.

All units must be correctly earthed/grounded and its own separate type RCD earth leakage trip installed which protects the machine only. See data sheet for the correct type.

The following limits of operation must not be exceeded. Failure to provide the necessary voltages will invalidate the warranty. This voltage must be available at the heat pump whilst running. The voltage must not drop below the above figures when starting the compressor.

	Minimum	Maximum
Voltage		
Three-phase machines	360V	440V
Cycle frequency (50Hz)	47.5Hz	52.5Hz

3.7 CONNECTING THE HEAT PUMP TO THE POWER SUPPLY

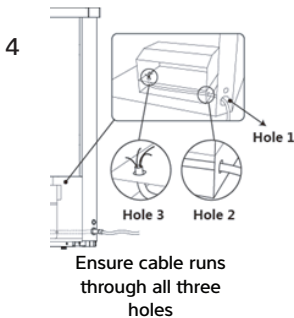
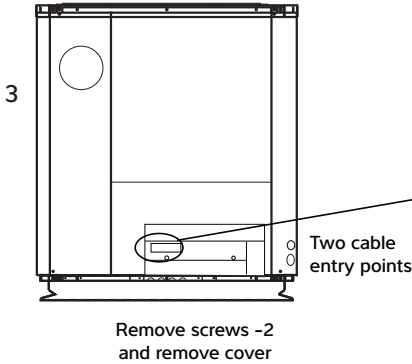
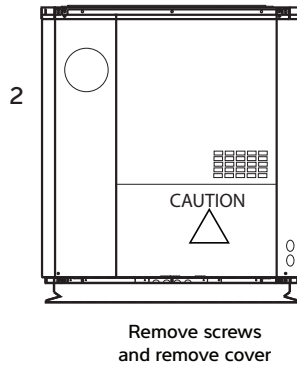
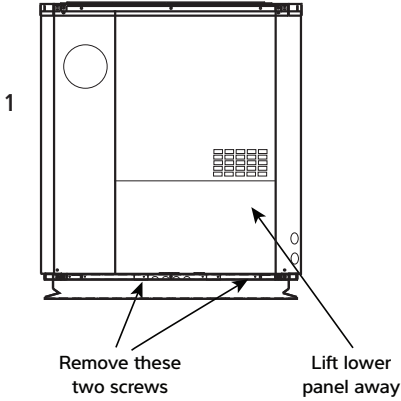

5 Replace all covers with retained screws.

Note:

The illustrations show the IPT 50 heat pump. The instructions are the same for the IPT 100 heat pumps.

Three phase

Terminals in Heat Pump Electrics enclosure

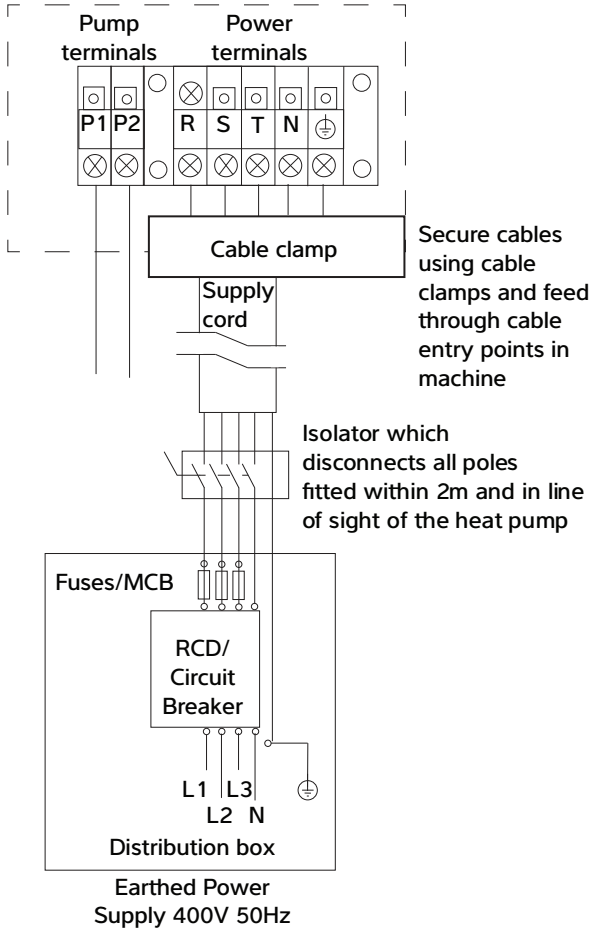

3.8 POOL PUMP SYNCHRONISATION TERMINALS P1 AND P2

***The installer will need to adjust parameter P0 when using this feature.**

For installations where the pool filter pump runs continuously, these terminals do not need to be used.

For installations where a timeclock controls the pool filter pump, and the same pump provides water flow to the heat pump, the heat pump can override "pump off" periods to ensure the pool is heated/cooled. To activate this setting please speak to your installer.

When installed in parallel with the timeclock, the pool filter pump will run when:

- a) a block period of "pump on" has been set on the time clock for filtration purposes.
- b) the heat pump runs the pool filter pump for temperature sampling and if the pool subsequently requires heating/cooling.

This feature operates by over-riding the timeclock for 3 minutes to circulate the pool water through the heat pump to sample the water temperature. The default sampling time interval is 1 hour.

If the measured temperature is more than 1°C from the set temperature, the point heat pump will continue to run the filter pump and heat/cool the pool. If the measured temperature is within 1°C of the set temperature, the filter pump will be turned off until the next sampling period, or the next timeclock "pump on" period.

When the pool pump is already running, and the heat pump is not heating/cooling, the heat pump will sample the water temperature once per hour and will start heating/cooling if needed. **The heat pump will ignore a demand to heat/cool the pool until the sampling timer (default 1 hour) has elapsed*.**

This feature will reduce the pool filter pump run time to minimise pump energy usage.

*If the pool filter pump is later changed to run continuously, it is recommended to de-activate this setting so the heat pump will respond to a heating/cooling demand without waiting for the sampling time interval to elapse. To deactivate this setting please speak to your installer.

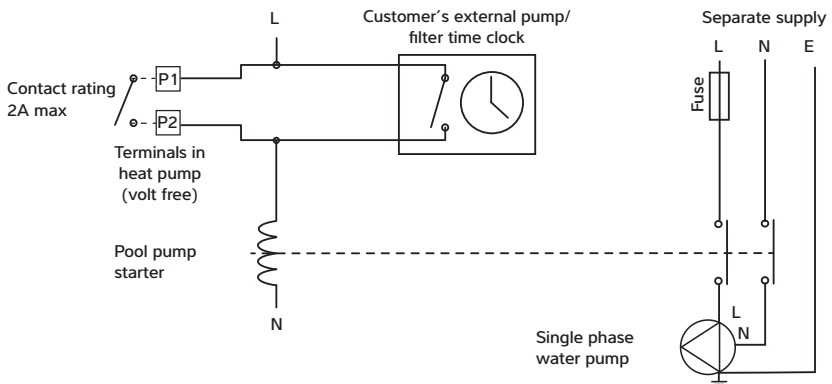

3.9 INSTALLING THE OPTIONAL REMOTE CONTROLLER

This optional accessory replaces the integral controller and can be installed up to 10m away.

Take the lid off the IPT to gain access to the existing controller. Remove the upper and lower front covers. Disconnect the plug from the socket (inside sleeving) on the back of the controller as shown.

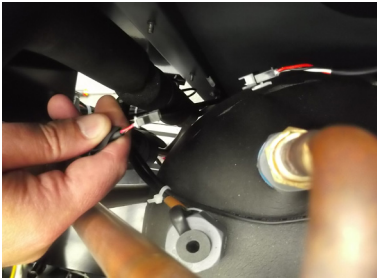

Feed the cable from the remote controller through the upper cable access point.



Connect the lead, and slide the sleeving back over the connectors. Secure the sleeving with a cable tie.



Route the cable inside the IPT securing it where necessary. Make sure there is a drip loop and that the connector is above the lowest point in the cabling.

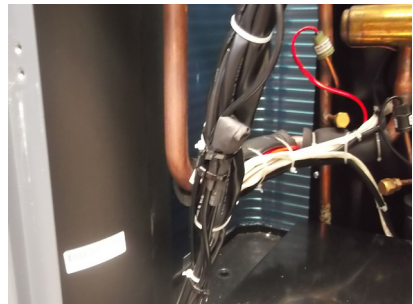

OWNER/INSTALLATION MANUAL

Connect the lead.



Remove the two screws from the back of the Remote Controller.



Remove the appropriate knock out and fit the back of the box to the wall.

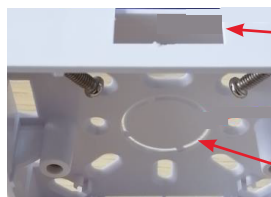

Inlet for exposed cable.

Inlet for concealed cable.

If the cable is concealed, fit the grommet in the hole to protect the cable from rubbing.

Secure the cable from the controller in the IPT

Refit the front covers and the top cover.

To check that the installation is correct, set the temperature on the remote controller to slightly higher than the pool water. The IPT should run to heat the pool, immediately if the pump synchronisation is not in use, or at the next sampling period if pump synchronisation is in use.

3.10 REMOTE ON / OFF TERMINALS 5 AND 6

For installations where a remote On / Off function is required an external switch can be used to over ride the main On / Off switch  and power the heat pump on or off.

When the external switch contacts are closed the heat pump will power on and remain operational until the external contacts are broken.







The machine is supplied with a link installed between terminals 5 and 6 which should be removed and replaced with an external switching device as indicated.



4.0 USING YOUR HEAT PUMP

4.1 THE KEY PAD



Symbol	Designation	Function
	On/Off	1. Power on/Off 2. Wi-Fi Setting
	Lock/Unlock and Heat Mode	1. Lock/Unlock Screen 2. Heating mode (18-40°C) 3. Cooling mode (12-30°C) 4. Auto mode (12-40°C)
	Speed mode	1. Boost  2. Whisper 
	Up/Down	Temperature setting

The buttons will turn dark when the controller is locked.

4.2 OPERATING INSTRUCTIONS

IMPORTANT

Remember that at startup there is a 1 minute time delay before the heat pump starts

a. Screen lock

1. Press  for 3 seconds to lock or unlock the screen. The buttons will turn dark when the controller is locked.
2. Automatic lock period: 30 seconds if no operation.

b. Power on

Press  for 3 seconds to unlock screen.

Press  to power on the heat pump.



c. Temperature setting

Press  and  to display and adjust the set temperature.



d. Mode selection

1. Heating/Cooling/Auto

Press  to switch between heating, cooling, and automatic modes.

Mode	Symbol	Water temperature setting range
Heating		18-40°C
Cooling		12-30°C
Auto		12-40°C

e. Speed Mode selection

Press  to switch between Boost mode  and Whisper mode. 

Default mode: Boost. 







Please choose Boost mode  for initial heating.

f. Wi-Fi

When the screen is on,  press for 3 seconds, after  flashes, enter Wi-Fi connection.

Connect Wi-Fi on mobile phone and input password, then control equipment by Wi-Fi. When APP connects Wi-Fi successfully  light is on.

g. Defrosting

1. Automatic defrosting: When the heat pump is defrosting, the  lamp flashes; after defrosting the  lamp stops flashing.
2. Forced defrosting: When the heat pump is heating and the compressor has been running continuously for at least 10 minutes, press  and  simultaneously for 5 seconds to start forced defrosting.
The  lamp flashes and defrost starts, when the  lamp stops flashing defrosting stops.

The interval between forced defrosts must be more than 30 minutes.

During a normal defrost the heat pump may exhaust a significant amount of vapour or mist into the air

4.3 USING THE APP

a. APP Download



Android please download from



iOS please download from



b. Account registration

1. Register by mobile or E-mail.

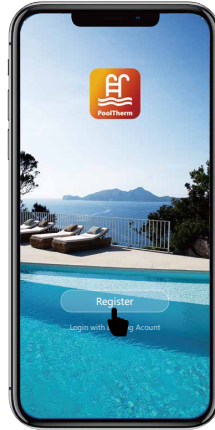

2. Mobile or E-mail registration.

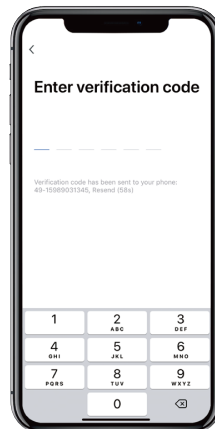
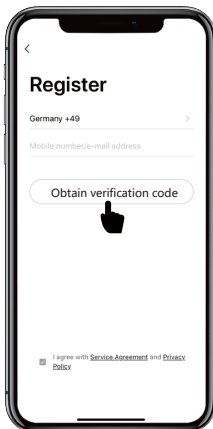

c. Create family

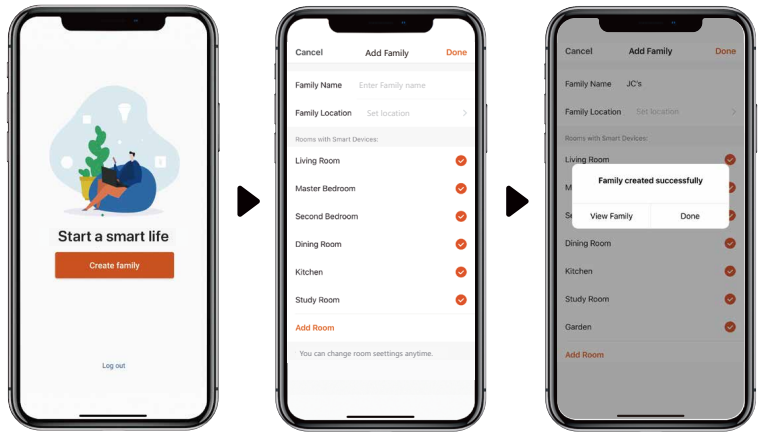





d. APP Pairing



Ensure you have your SSID and Password available before attempting the pairing function.

Please make sure you are connected to the Wi-Fi.

1. Press “” for three seconds to unlock the screen.
2. Press “” for three seconds then release, after hearing the beep, enter the Wi-Fi code. During connection the “” flashes. When the APP connects to the Wi-Fi successfully the “” light will come on.

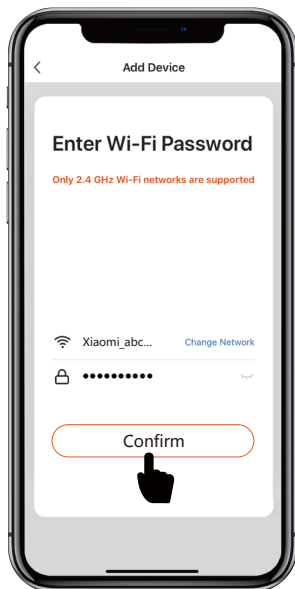
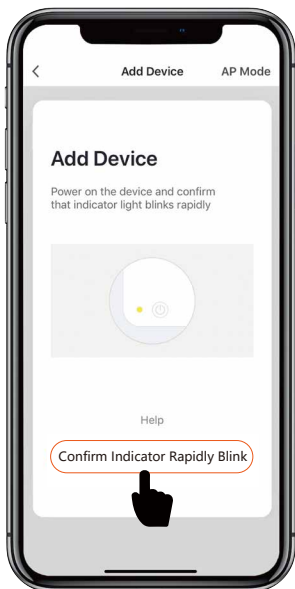
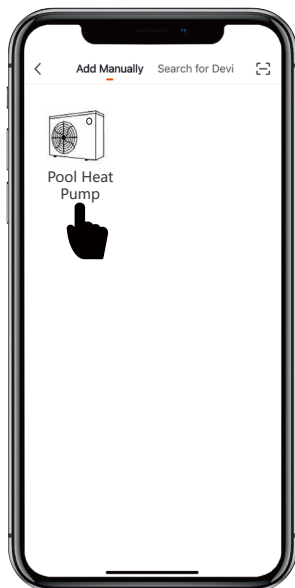
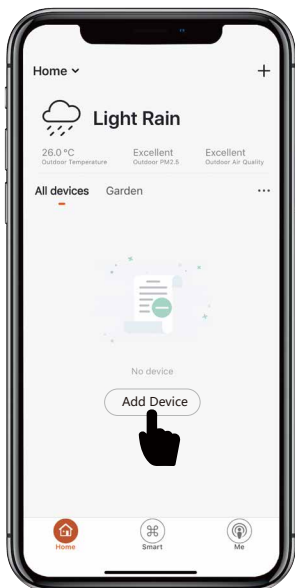

Before pressing confirm ensure the “” indicator is blinking rapidly. If not repeat stages 1 and 2 on the heat pump main control panel until the indicator is blinking rapidly before pressing confirm.

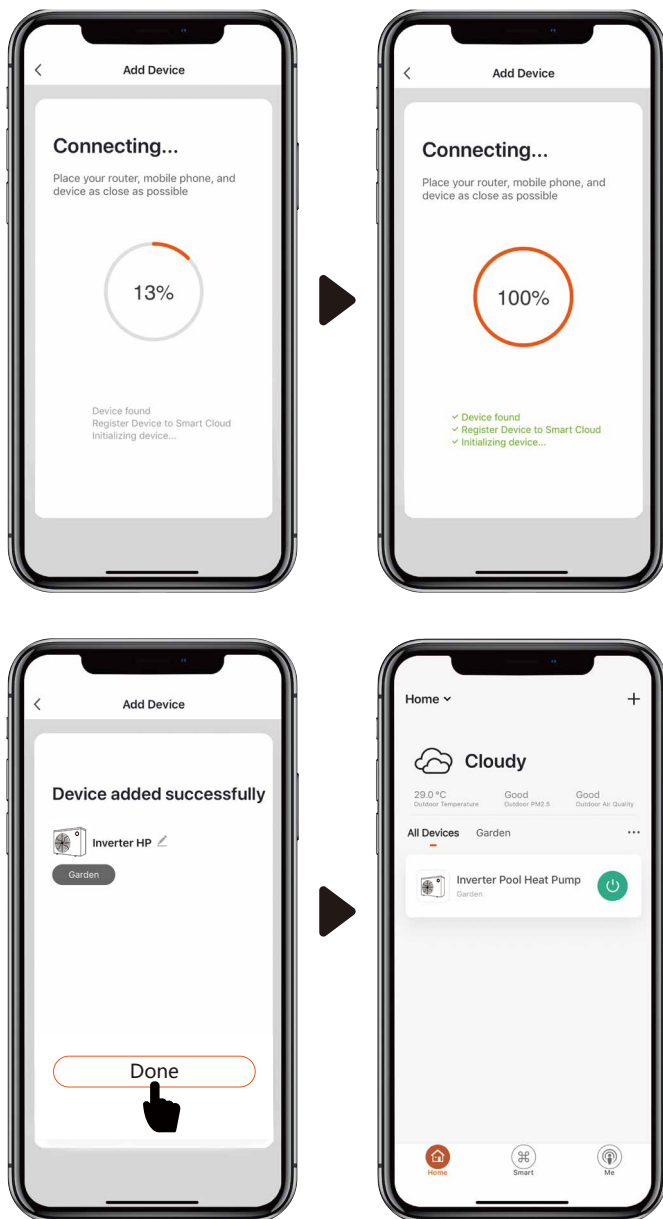

e. Operation

1. For heat pump with Heating function only :



2. For heat pump with Heating and Cooling function :

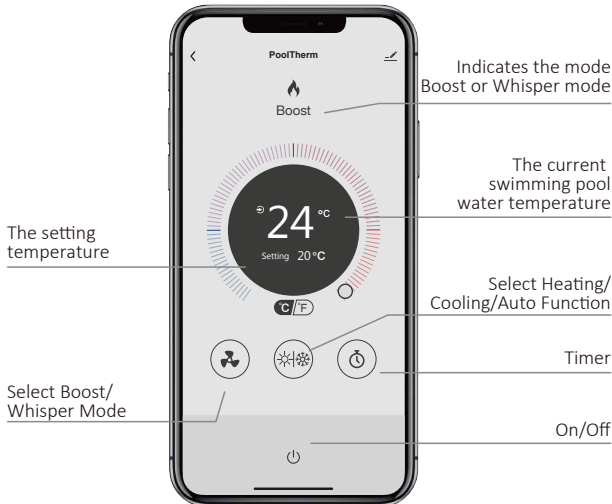

f. Share devices to your family members

After pairing, if your family members also want to control the device.

Please let your family members register the APP first, and then the administrator can operate as below:

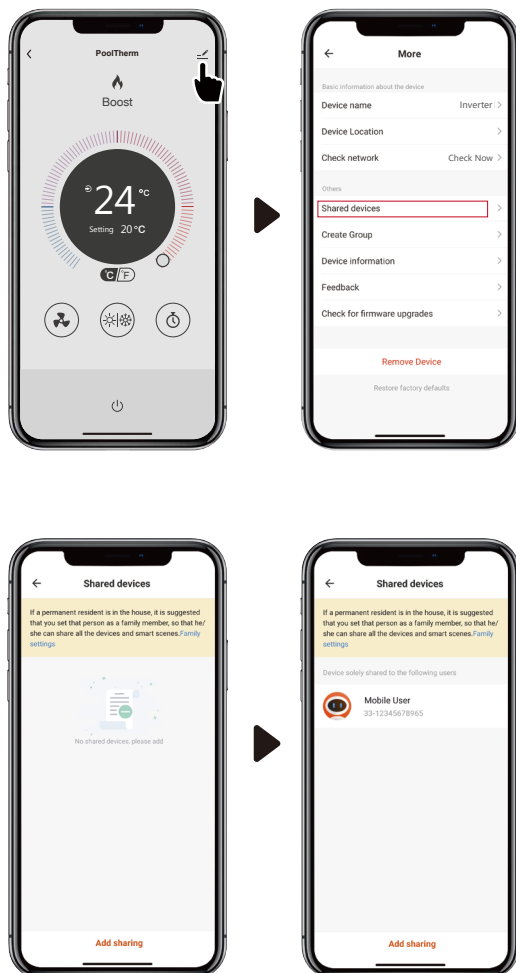

Notes:





1. The weather forecast is just for reference.

App is subject to updating without notice.

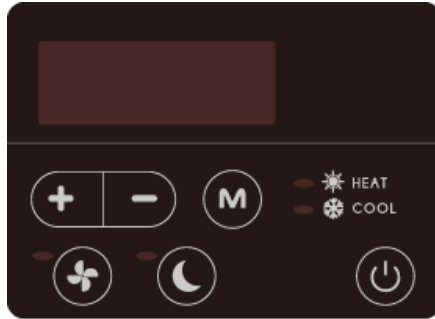
4.4 USING THE OPTIONAL REMOTE CONTROLLER

4.5 THE KEY PAD

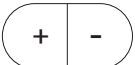

Symbol	Function
	Power On/Off
	Heating/Cooling/Auto mode
	Press to start Boost mode
	Press to start Whisper mode
	Temperature setting and display.

4.6 OPERATING INSTRUCTIONS

a. Power On & Power Off

Press  to power on or power off the heat pump.

b. Temperature Setting

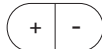
Press  to display and adjust temperature.



c) Mode selection

1. Heating/Cooling/Auto modes

Press  to choose heating, cooling and automatic mode.

In heating mode the  light is on.

In cooling mode the  light is on.

In automatic mode the  and  the lights are on.

2. Whisper and Boost modes

Press  to start Boost mode, and light will turn on.

Press  to start Whisper mode, and light will turn

on. (Default mode is Boost).





Please choose Boost mode  for initial heating.

c. Defrosting

1. Automatic defrosting

When machine is defrosting, the  lamp flashes; after defrosting the  lamp is illuminated.

2. Forced defrosting

When the heat pump is heating and the compressor has been working continuously for at least 10 minutes, press  and  on the touchscreen controller simultaneously for 5 seconds to start forced defrosting. The  lamp flashes and defrost starts, when the  lamp stops flashing defrosting stops.

The interval between forced defrosts must be more than 30 minutes.

During a normal defrost the heat pump may exhaust a significant amount of vapour or mist into the air.

It is normal for ice to form on the evaporator fins but if significant amounts of ice remain after a defrost, switch the heat pump off and allow the ice to melt.

5.0 TESTING

Inspect the heat pump before use

- Check that the fan, air inlets and outlets are not obstructed.
- It is prohibited to install refrigeration pipe or components in corrosive environment.
- Double check that the main power switch is off before making checks.
- Check that the electric wiring conforms to the electric wiring diagram and that the machine is earthed.
- After starting check the temperature setting.

5.1 HEAT PUMP MALFUNCTION

WARNING: Isolate heat pump electrically, and wait 3 minutes before removing panels or entering heat pump.

- Refer to the user check list in section 5.2 and the error codes listed in section 5.3 before initiating a service call.
- Do not attempt to interfere with any internal control settings as these have been factory calibrated and sealed.
- Any sign of abnormal operation such as water dripping should be reported immediately to the installer. If in doubt or if advice is required contact the Service support team on telephone +44(0)1621 856611 (option 4).

Fault	Reason	Solution
Heat pump doesn't run	No power	Wait until the power is restored
	Power is switched off	Switch on the power
	Fuse has blown	Check and change the fuse
	The breaker is off	Check and turn on the breaker
Fan running but with insufficient heating	Evaporator blocked	Remove the obstructions
	Air outlet blocked	Remove the obstructions
	Compressor start delay	Wait for the delay timer to time out
Display normal, but no heating	Set temperature too low	Set desired heating temperature
	Start delay	Wait for the delay timer to time out
Inaccurate switch action	Stop the machine, and cut off the power supply immediately, then contact your dealer	
The fuse blows frequently or leakage circuit breaker trips frequently		
If above solutions don't work, please contact your installer with detailed information and your model number. Don't try to repair it yourself.		

5.2 PROTECTION CODES

These codes indicate machine stopping due to external circumstances.

These are not faults with the heat pump.

No	Display	Reason	Solution
1	E3	No water flow through the heat pump.	Check water circuit and pool pump.
2	E4	Three phase rotation protection.	Check phases connected correctly (Electrician required)
3	E5	Voltage of power supply to heat pump is out of range.	Check the power supply.
4	E6	Low water flow indicated by more than 10°C difference in inlet and outlet temperature.	Check water flow and pool pump.
5	Eb	Ambient temperature is out of range, either lower than -7°C or higher than 43°C. (BLY models), or lower than 10°C or higher than 55C (BHC models).	If outside, wait for ambient conditions to improve (winterisation may be required). If installed in a sheltered place, check for air recirculation.
5	Ed	Frost protection. The heat pump runs in heating mode for a short time when in standby mode to prevent frost build up. This does not replace winterisation.	Heat pump will resume standby once process is completed.

5.3 FAULT CODES

When the heat pump displays these error codes
please contact your installer for advice.

No	Display	Description of fault code
1	E1	High pressure alarm
2	E2	Low pressure alarm
4	E7	Water outlet temp out of range alarm
5	E8	High exhaust temp alarm
6	EA	Evaporator overheat alarm (only in cooling mode)
7	P0	Controller communication failure
8	P1	Water inlet temp sensor failure
9	P2	Water outlet temp sensor failure
10	P3	Gas exhaust temp sensor failure
11	P4	Evaporator coil pipe temp sensor failure
12	P5	Gas return temp sensor failure
13	P6	Cooling coil pipe temp sensor failure
14	P7	Ambient temp sensor failure
15	P8	Cooling plate sensor failure
16	P9	Current sensor failure
17	PA	Restart memory failure
18	F1	Compressor drive module failure
19	F2	PFC module failure
20	F3	Compressor start failure
21	F4	Compressor running failure
22	F5	Inverter board over current protection
23	F6	Inverter board overheat protection
24	F7	Current protection
25	F8	Cooling plate overheat protection
26	F9	Fan motor failure
27	Fb	Power filter plate - no power protection
28	FA	PFC module over current protection

6.0 MAINTENANCE



Isolate the power supply of the heat pump and wait 3 Minutes before cleaning, examination or repair.

Cover the heat pump body when not in use.

Please clean this machine with household detergents or clean water, NEVER use petroleum spirit, thinners or any similar fuel.

Check bolts, cables and connections regularly.

Regularly check condensate drain hose for blockages and clear.

Keep evaporator clean and free from blockages with a soft brush. To access the evaporator first isolate the heat pump electrically using the mains isolator switch and wait 3 minutes before removing any panels.

- Remove the screws at the bottom of the grilles covering the evaporator, press the panels upwards and pull away from the machine.
- Remove dirt and debris from the evaporator with a soft brush [do not use excessive force as this may damage the evaporator fins].
- Warning : Care must be taken not to touch the evaporator fins with your hands as the edges are sharp and may cause injury.
- Replace panels in reverse order, reconnect to the electrical supply and switch the heat pump on.

Repair, service and disposal of redundant heat pumps must be completed by authorised technicians. It is illegal to allow refrigerant gases to escape to air.

7.0 TROUBLE SHOOTING COMMON FAULTS



Do not attempt to work on the equipment by yourself. Improper operation may cause danger.

Requirements for service personnel

Any person who is involved with working on or breaking into a refrigerant circuit should hold a current valid certificate from an industry-accredited assessment authority, F-Gas registered.

Do not attempt to work on the equipment by yourself.

8.0 I-PAC 50/100BLY, I-PAC 50/100BHC DATASHEET

MODEL	UNITS	IPT 50 BLY	IPT 100 BLY	IPT 50 BHC	IPT 100 BHC
PERFORMANCE CONDITION: Air 27°C/Water 27°C/RH 80%					
Heating capacity	kW	60.2	115	60.2	115
COP range		6.6 to 15.2	6.5 to 15.0	6.6 (100% speed)	6.0 (100% speed)
Average COP at 50% speed		10.5	10	10.5	10
PERFORMANCE CONDITION: Air 15°C/Water 26°C/RH 70%					
Heating capacity	kW	40.1	80.8	40.1	80.8
COP range		4.9 to 7.7	4.8 to 7.5	4.9 (100% speed)	4.8 (100% speed)
Average COP at 50% speed		7.0	6.7	7.0	7.0
PERFORMANCE CONDITION: Air 35°C/Water 28°C/RH 80%					
Cooling capacity	kW	26.8	53.5	-	-
PERFORMANCE CONDITION: Air 45°C/Water 32°C/RH 80%					
Cooling capacity	kW	-	-	25.1	50.3
TECHNICAL SPECIFICATIONS					
Operating air temperature	°C	-7°C to 43°C		10° to 55°C	
Water heating setting range	°C	18°C to 40°C		18°C to 40°C	
Water cooling setting range	°C	12°C to 30°C		12°C to 30°C	
POWER SUPPLY		400V ~N Three phase 50 Hz/60 Hz		400V ~N Three phase 50 Hz/60 Hz	
Rated power input	kW	2.1 to 8.18	4.25 to 17.0	2.26 to 8.9	4.68 to 17.5
Rated input current	A	3.05 to 11.9	6.16 to 24.7	3.27 to 12.9	6.78 to 25.3
Maximum input current	A	19	38	19	38
Rated RCD type F	mA	30	30	30	30
Rated Fuse aM / MCB type C	A	23	45	23	45
Sound pressure level at 10m	dB(A)	33 to 41	35 to 44	33 to 41	33 to 44
Recommended water flow rate	m ³ /h	20 to 25	40 to 50	20 to 25	40 to 50
Pool water connections	mm	75mm Female	110mm Female	75mm Female	110mm Female
GENERAL DATA					
Net dimensions (w x d x h)	mm	1000 x 1075 x 1260	2100 x 1090 x 1280	1000 x 1075 x 1260	2100 x 1090 x 1280
Packed dimensions (w x d x h)	mm	1200 x 1100 x 1310	2160 x 1170 x 1330	1200 x 1100 x 1310	2160 x 1170 x 1330
Net weight	kg	230	448	230	448
HERMETIC SYSTEM					
Refrigerant charge R410a/ CO ₂ equivalent	kg/tons	8.0 / 16.70	16.0 / 33.41	8.0 / 16.70	16.0 / 33.41

Notes: Heat pump performance parameters are subject to change without notice. ALWAYS refer to the nameplate.

Global warming potential(GWP) R410a - 2088.

The data is subject to change without prior warning.

9.0 I-PAC 50/100BLY, PERFORMANCE GRAPHS

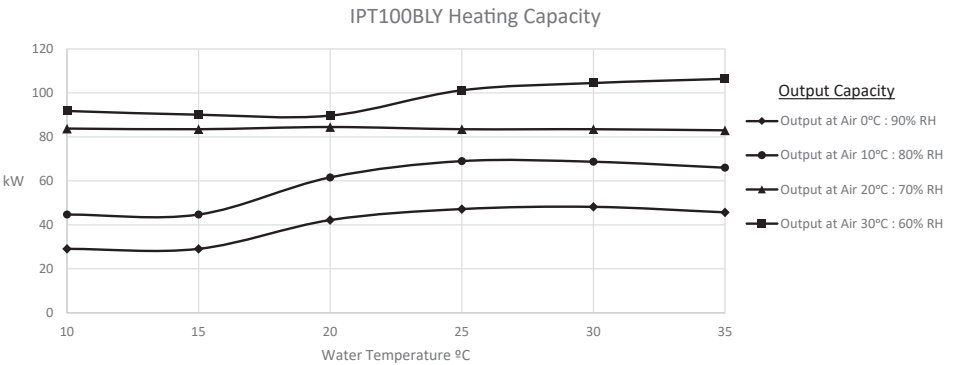
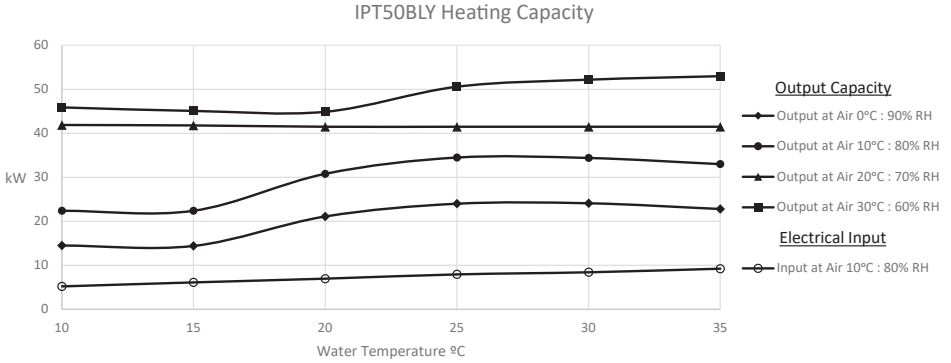

10.0 PRODUCT DRAWINGS

I-PAC 50BLY / I-PAC 50BHC

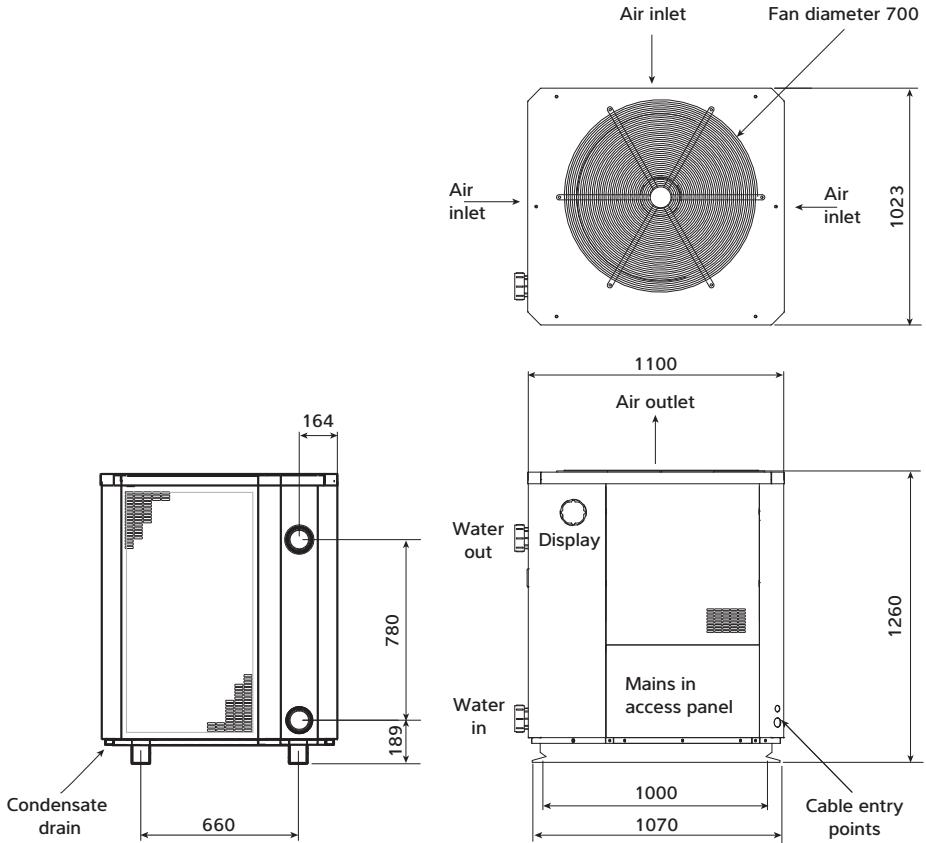

I-PAC 50BLY / I-PAC 50BHC GRILLE APERTURES

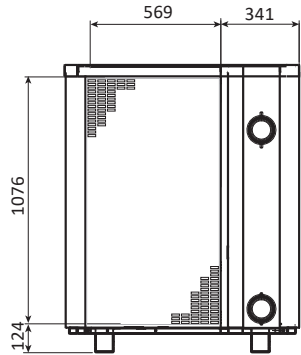
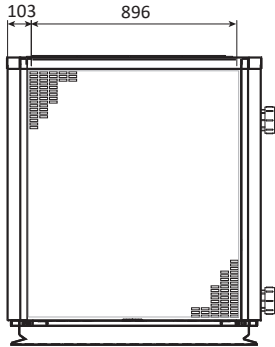
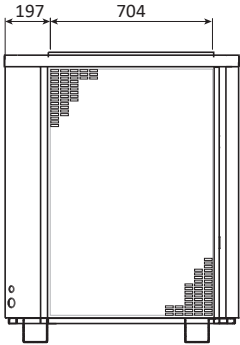
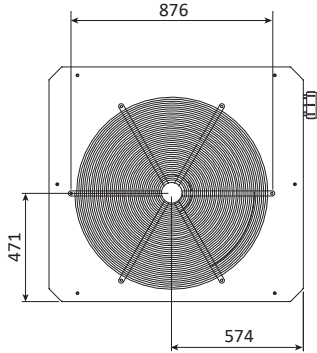

I-PAC 100BLY / I-PAC 100BHC

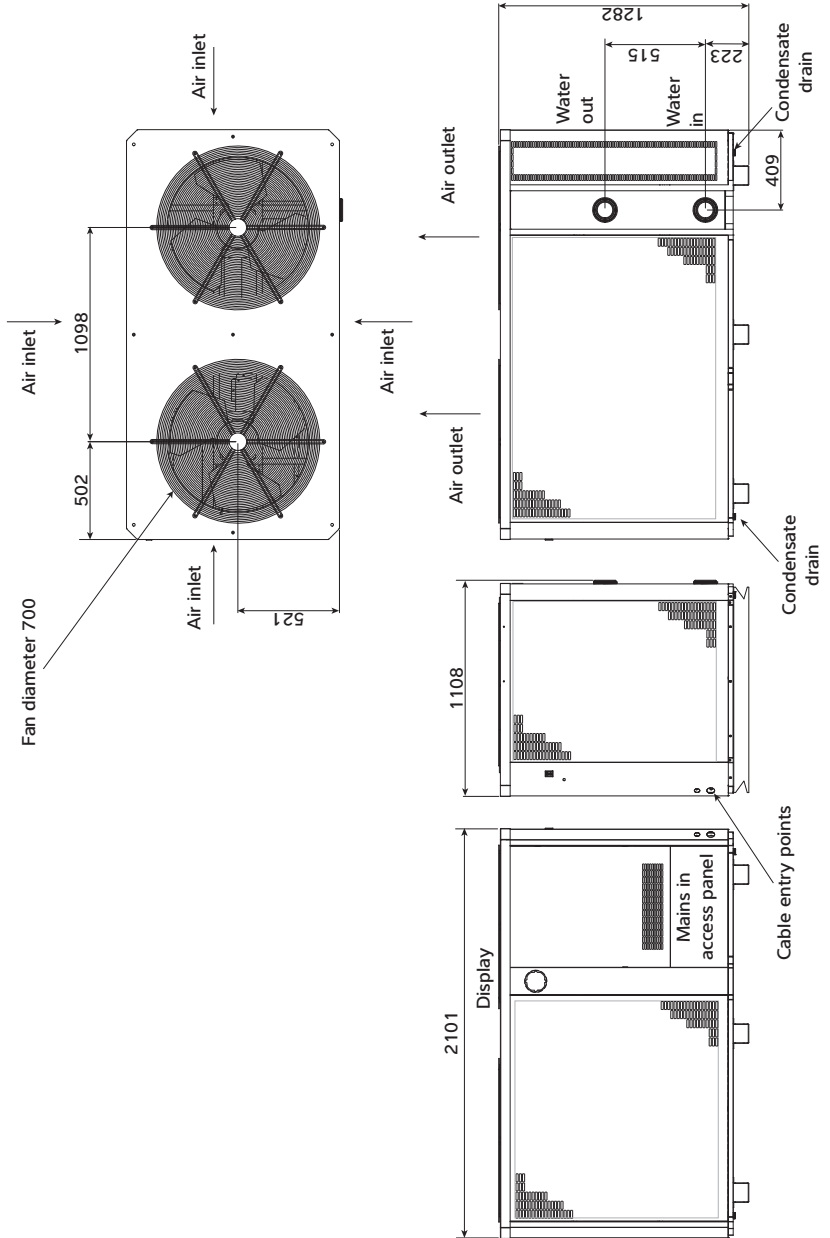

I-PAC 100BLY / I-PAC 100BHC GRILLE APERTURES

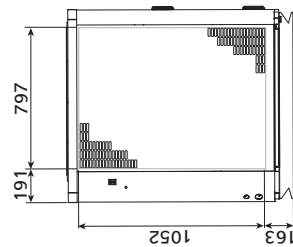
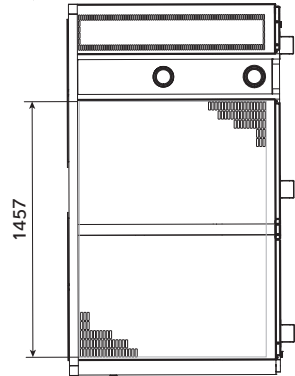
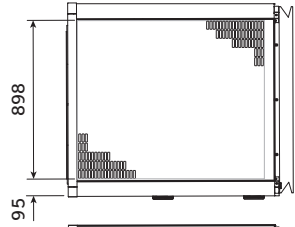
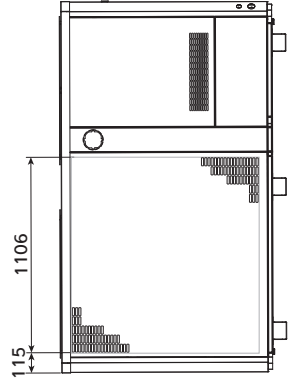
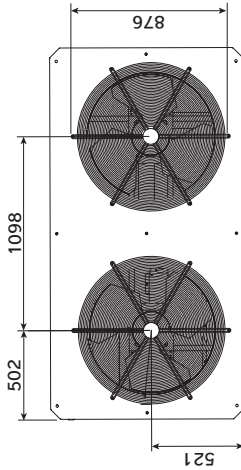

11.0 WINTERISATION PROCEDURE

WARNING. Isolate heat pump before opening! As heat pump embodies electrical and rotational equipment, it is recommended for your own safety that a competent person carries out the following procedure.

(Drain Down Procedure)

ALL MODELS

Objective

To provide frost protection

To eliminate corrosion problems

To inhibit electrical components

1. Switch off electrical supply to heat pump.
2. Remove external fuses and keep in safe place away from heat pump to prevent accidental operation of heat pump.
3. Ensure water circulation pump is switched off.
4. Drain water from heat pump by:
 - a) Drain valve if fitted.
 - b) Disconnecting pipework to and from heat pump.
 - c) Remove condenser drain down cover.
 - d) Flush through water circuit in heat pump by using CLEAN TAP WATER (NOT POOL WATER) via hose into outlet connection – run for 10 minutes minimum, use spray nozzle if available.
 - e) Allow to drain – fit plastic bags secured by elastic bands over water connections.
5. Uncover electrical enclosure (page 16) and liberally spray interior of unit, with moisture repellent aerosol WD-40 or similar, reseal enclosure.
6. If heat pump located outside, protect from weather by covering with VENTILATED cover. A bespoke cover is available. Do not use plastic sheet as condensation can occur within unit.

If this procedure is not adopted and frost or corrosion damage results then the warranty will become invalid.

11.1 START UP PROCEDURE AFTER WINTERISATION

1. Replace covers (if not fitted).
2. Remove front grille – using soft brush clean finned surfaces of heat pump. Replace panel.
3. Remove plastic covers on water connections and reconnect water piping or close drain valve.
4. Start up water circulating pump and leave running for at least ¼ hour to establish flow and enable any air in system to escape.
5. Replace fuses to heat pump circuit.
6. Switch on heat pump.
7. Check control thermostat is set to required pool temperature.
8. Check daily to ensure pool water is at correct pH and has correct chemical balance. See section 11.0 Warranty conditions.

Any significant periods of non-use need to be recorded on the heat pump record log. See pages 43-44

12.0 WARRANTY CONDITIONS

The following exclusions apply to the warranty given by Dantherm Ltd. No claims will be accepted if:

1. The heat pump is installed in any way that is not in accordance with the current procedures as defined by Dantherm Ltd.
2. The heat pump has been worked upon or is adjusted by anyone other than a person authorised to do so by Dantherm Ltd.
3. The heat pump is incorrectly sized for the application.
4. The water flow through the machine is outside the specified limits.
5. The water pH level and/or chemical balance is outside the following limits:

Acidity pH	pH	7.2 - 7.8
Total Alkalinity, as CaCO ₃	ppm	80 - 120
Total Hardness, as CaCO ₃	ppm	150 - 250
Total Dissolved Solids	ppm	1000
Maximum Salt Content	ppm	35000
Free Chlorine Range	ppm	1 - 2 Domestic
Free Chlorine Range	ppm	3 - 6 Commercial
Superchlorination	max	30ppm for 24 hrs
Bromine	ppm	2 - 5
Baquacil	ppm	25 - 50
Ozone	ppm	0.9 Max
Maximum Copper Content	ppm	1
Aquamatic Ionic Purifier	ppm	2 Max

6. The heat pump has suffered frost damage.
7. The electrical supply is insufficient or in any way incorrect.

8. The fan amps and duct pressure are outside the specified limits.
9. The air flow to and from the machine is outside the specified limits.

If in doubt or if advice is required please contact the Dantherm Group UK Service Department by calling +44 (0)1621 856 611 (option 4) or email service.department@dantherm.com

Please give **MODEL NUMBER** and **SERIAL NUMBER** of your heat pump when making technical or service enquiries. This will assist in correct diagnosis and ensure service can be provided with the minimum delay.

13.0 HEAT PUMP RECORD LOG

In order to comply with F-Gas regulations, it is necessary for hermetically sealed systems with more than 6kg refrigerant to be leak tested annually.

The operator of the heat pump is responsible for seeing that the test is carried out.

A sample log sheet can be seen below.

Dantherm Ltd. is an F-Gas registered company. Certificate number REF1011570.

General information				
Plant name				Serial number
Location of plant				
Plant operator ¹				
Operator contact ²				
Refrigerant type				Refrigerant quantity installed (kg)
Plant manufacturer	Dantherm Ltd			Year of installation
Refrigerant Additions				
Date	Engineer ³		Amount added kg	Reason for addition
	Company	Name		
Refrigerant removals				
Date	Engineer		Amount removed kg	Reason for removal What done with recovered refrigerant
	Company	Name		
Name and address of recycling or reclamation facility				Certificate number if applicable
Leak tests				
Date	Engineer		Test result	Follow up action required
	Company	Name		

Continued on next page

Follow up actions				
Date	Engineer		Related to test on	Actions taken
	Company	Name		
Testing of automatic leak detection system (if fitted)				
Date	Engineer		Test result	Comments
	Company	Name		
Periods of non-use				

¹ Name and address of company operating plant.

² Contact details of operator's nominated person responsible for F-Gas compliance.

³ Company and technician carrying out work, with details to provide evidence of compliance.

IMPORTANT The company carrying out refrigerant checking and removals, and the owner of the equipment need to keep records for FIVE YEARS.

When this heat pump is decommissioned the refrigerant gas is to be recovered in accordance with current environmental legislation.

14.0 DECLARATION OF CONFORMITY



DANTHERM GROUP

Dantherm Ltd.
Unit 12, Galliford Road
Maldon CM9 4XD
United Kingdom

+44 (0)1621 856611
sales.uk@dantherm.com
danthermgroup.co.uk
VAT: GB 223 5572 21

DECLARATION OF CONFORMITY

We hereby certify that the following Calorex models:

IP508LY, IPT1008LY, IPT50BHC, IPT100BHC electrically driven refrigeration heat pumps.

Conforms with

EN 60335-1:2012+A11+A13+A14+A2+A15, EN 60335-2-40:2003+A1+A2+A11+A12+A13, EN 62233:2008 and therefore comply with the Low Voltage Electrical Equipment Directive 2014/35/EU.

Conforms with

EN ISO 12100:2010, EN ISO 13857:2019, EN ISO 13850:2015, and therefore comply with the Supply of Machinery (Safety) Directive 2006/42/EC.

Conforms with

EN IEC 61000-3-2:2019+A1:2021, EN 61000-3-3:2013+A1:2019, EN IEC 55014-1:2021, EN IEC 55014-2:2021 and therefore comply with the Electromagnetic Compatibility Directive 2014/30/EU.

Compliant to RoHS Directive [EU] 2015/863 and [EU] 2017/2102.

Inside the scope of the WEEE Directive 2012/19/EU.

Jakob Bonde Jessen
Group Chief Operating Officer

Date 16/3-2022

Document number : 1008489 issue 1



AERIAL

 **calorex**

Dantherm

MASTER

Dantherm A/S

Marienlystvej 65
DK-7800 Skive
Denmark
t. +45 96 14 37 00

Dantherm Ltd.

Unit 12, Galliford Road
Maldon CM9 4XD
United Kingdom
t. +44 (0)1621 856611

Dantherm GmbH

Oststraße 148
22844 Norderstedt
Germany
t. +49 40 526 8790

Dantherm S.p.A.

Via Gardesana 11
37010 Pastrengo (VR)
Italy
t. +39 045 6770533

Dantherm Sp. z o.o.

ul. Magazynowa 5a
62-023 Gądkki
Poland
t. +48 61 65 44 000

Dantherm SP S.A.

C/Calabozos 6
(Polígono Industrial)
28108 Alcobendas, Madrid
Spain
t. +34 91 661 45 00

Dantherm SAS

23 rue Eugène Henaff
69694 Vénissieux Cedex
France
t. +33 4 78 47 11 11

Dantherm AS

Løkkeåsveien 26
3138 Skallestad
Norway
t. +47 33 35 16 00

Dantherm AB

Fridhemsvägen 3
602 13 Norrköping
Sweden
t. +46 (0)11 19 30 40

Dantherm LLC

Transportnaya 22/2
142800, Stupino
Moscow
Russia
t. +7 (495) 642 444 8

MCS China

Unit 2B, No. 512
Yunchuan Road
Baoshang, Shanghai, 201906
China
t. +8621 61486668

Termigo S.L

Carrer dels Velluters, 18-2
46980 Paterna, Valencia
Spain
t. +34 961 524 866

AirCenter AG

Täferstrasse 14
CH-5405 Baden Dättwil
Switzerland
t. +41 43 500 00 50

Heylo GmbH

Im Finigen 9
28832 Achim
Germany
t. +49 4202 97550

SET Energietechnik GmbH

August-Blessing-Straße 5
Hemmingen, 71282
Germany
t. +49 7150 94540

Manufacturers details:

Dantherm Ltd.

Unit 12, Galliford Road
Maldon CM9 4XD
United Kingdom
t. +44 (0)1621 856611
e. service.department@dantherm.com