

TECHNICAL MANUAL

HYDROSTAR PUMPS

7.1



TUV DOC
HSTAR
ISSUE NUMBER 1.
JAN: 2002.

HYDROSTAR PUMP

The Waterco Limited Hydrostar pump has been hydraulically designed for maximum flow characteristics.

Waterco limited has incorporated state of the art engineering plastics and motor design to provide a quality high performance pump that caters for all types of swimming pool applications, especially commercial swimming pools.

Its uses also include ancillary systems such as water features, swimjets, in floor cleaning systems and aqua culture purposes.

The Hydrostar pump comes with a one piece body, a clear hair and lint pot lid with quarter turn lock down lid assembly. The pump also has a massive lockable strainer basket which is ideal for any areas which are subject to large quantities of debris.

The Hydrostar pump comes with drain plug to ensure complete pump drainage.

CONSTRUCTION

The Hydrostar pump has been constructed with high quality engineering plastics, GF/ABS, GF/PP. The impeller and diffuser are constructed with glass filled Noryl.

The O- rings are leak proof and are re-usable; the mechanical seal is of high grade carbon-graphite with stainless steel spring assembly.

The mechanical seal assembly is suitable for use with chlorine, bromine, ozone, Baquacil, iodine and mild salt water applications.

The hair and lint pot lid is constructed using poly-carbonate materials.

DIMENSIONS

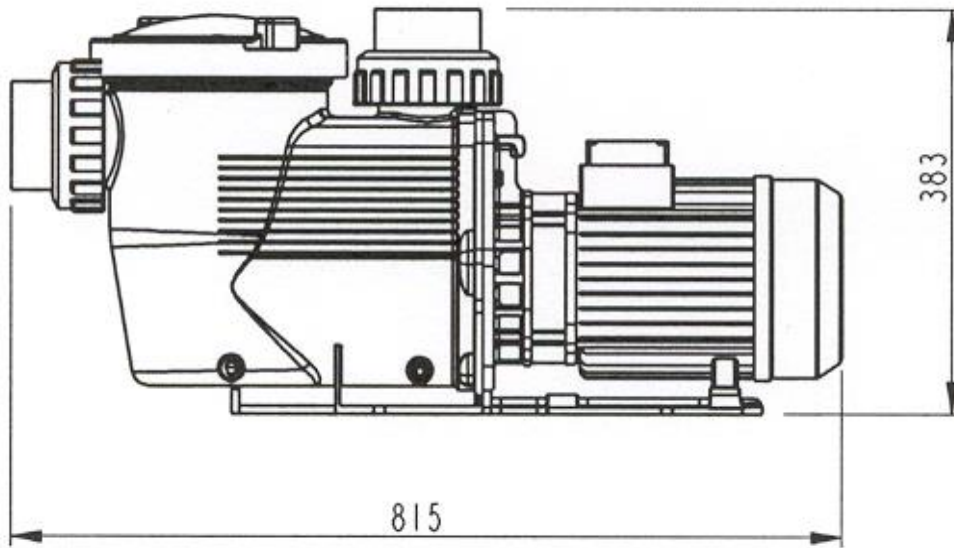

MOTORS

The Hydrostar pump comes with both **single** and **three** phase motors from 2.0hp to 3.5hp and three phase only for the 4.0hp, 5.0hp, 6.0hp and 7.0hp.

The motor used is a European made motor from E.M.G. Italy.

The motors are totally enclosed and are fan cooled. **The motors come with an IP55 protection rating**, which is jet and dust proof and has built in thermal overload protection for **(single phase units only)**. This protection applies for motor only.

Hydrostar pump protection is IPX5.

PUMP MODEL	KW	AMPS	PHASE	HP	VOLTS	CYCLE Hz	MOTOR IP	PUMP RATING
HYDROSTAR 200	1.49	2.50	1	2.00	220-240	50Hz	55	IPX5
HYDROSTAR 250	1.86	3.27	1	2.50	220-240	50Hz	55	IPX5
HYDROSTAR 300	2.24	10.30	1	3.00	220-240	50Hz	55	IPX5
HYDROSTAR 350	2.61	12.00	1	3.50	220-240	50Hz	55	IPX5
HYDROSTAR 200 3PH	0.50	2.50	3	2.00	380-415	50Hz	55	IPX5
HYDROSTAR 250 3PH	0.62	3.80	3	2.50	380-415	50Hz	55	IPX5
HYDROSTAR 300 3PH	0.75	4.12	3	3.00	380-415	50Hz	55	IPX5
HYDROSTAR 350 3PH	0.87	4.41	3	3.50	380-415	50Hz	55	IPX5
HYDROSTAR 400 3PH	0.99	5.78	3	4.00	380-415	50Hz	55	IPX5
HYDROSTAR 500 3PH	1.24	6.00	3	5.00	380-415	50Hz	55	IPX5
HYDROSTAR 600 3PH	1.49	7.20	3	6.00	380-415	50Hz	55	IPX5
HYDROSTAR 700 3PH	1.74	8.30	3	7.00	380-415	50Hz	55	IPX5

Note: 3 phase motors kilowatts and amps in table are shown per phase.

MODELS

The Hydrostar pump is available in single and three phase models from 2.00hp to 3.50hp. The pump body thread is 65mm on the inlet and outlet and 65mm inlet / outlet unions are supplied.

The 4hp to 7hp model is available in three phase only. The pump body threads are 80mm on the inlet / outlet and 80mm unions are supplied.

CONNECTION & TESTING

The Hydrostar pump comes with a two meter electrical cable supplied ex factory for all **single phase units only**.

Three phase units are not supplied with cable.

When no cord is supplied or if the cord is damaged any new replacement cord shall not be lighter than:

- a) Heavy polychloroprene sheathed flexible cords (designated **245 IEC 66** or **H07RN-F** for models with more than 1kw power input.
- b) Ordinary polychloroprene sheathed flexible cords (designated **245 IEC 57** or **H05RN-F**) for models with less than 1kw power input.

The cord should be supplied and fitted with an o-ring (circular clip).

This cord is available from the manufacturer or any of its authorized distributors only.

Electrical cords must be fitted by licensed electricians only.



SMALLEST CROSS SECTION OF CONDUCTOR

NOMINAL (a) CURRENT	NOMINAL CROSS SECTION mm ²
< 0.2	Tinsel cord1)
>0.20 and < 3	0.5a)
> 3 and < 6	0.75
> 6 and < 10	1.00
> 10 and < 16	1.50
> 16 and < 25	2.50
> 25 and < 32	4.00
> 32 and < 40	6.00
> 40and < 63	10.0

Maximum length of cable from plug to gland is not to exceed 2 meters.

**ELECTRICAL CONNECTIONS • BRANCHEMENTS ELECTRIQUES
 CONEXIONES ELECTRICAS • COLLEGAMENTI ELETTRICI
 ELEKTRISCHE ANSCHLUSSE • LIGAÇÕES ELECTRICAS**

**SINGLE PHASE MOTORS • MOTEURS MONOPHASES
 MOTORES MONOFASICOS • MOTORI MONOFASE
 EINPHASIGE MOTOREN • MOTORES MONOFASICOS
 (230V.-50 Hz.)**

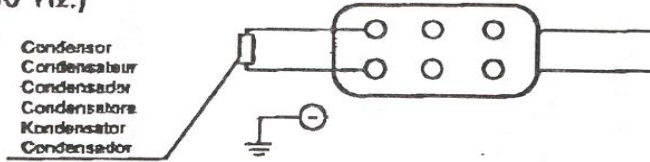

**THREE PHASE MOTORS • MOTEURS TRIPHASES
 MOTORES TRIFASICOS • MOTORI TRIFASE
 DREINPHASIGE MOTOREN • MOTORES TRIFASICOS
 (230/400V.-50 Hz.)**

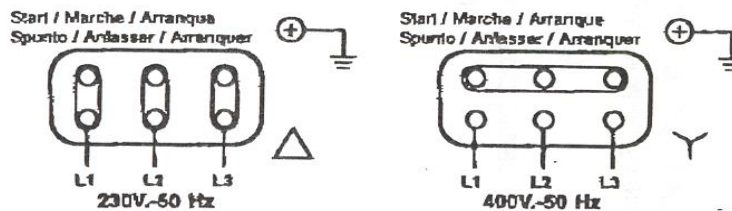

**CONEXIONES A RED • BRANCHEMENTS RESEAU ELECTRIQUE
 CONEXIONES A RED • COLLEGAMENTI ALLA RETE
 NETZANSCHLUSSE • LIGAÇÕES A REDE**

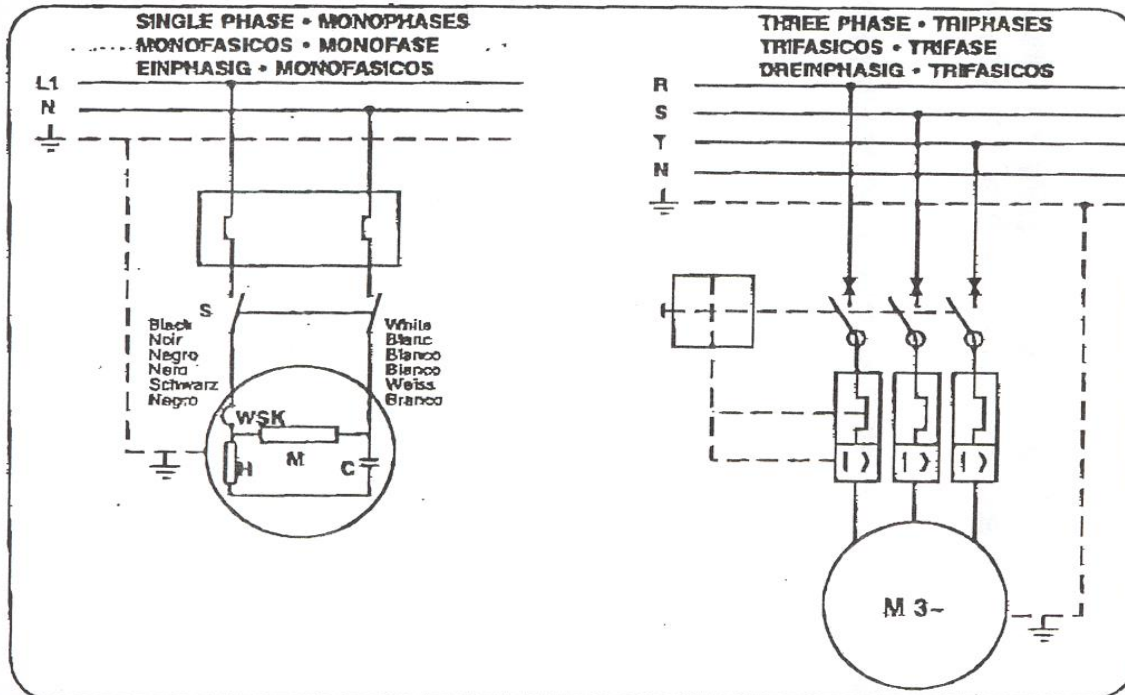

All Hydrostar pumps are 100% factory wet tested.

PACKAGING

The Hydrostar pump is packaged in a closely fitted cardboard carton. Added protection is ensured by the use of instapak foam in all cartons.

PUMP MODEL	CTN LGTH MM	CTN WPTH MM	CTN DTH MM	PACK WEIGHT	PALLET QTY
HYDROSTAR 200	835	295	430	25	SINGLE
HYDROSTAR 250	835	295	430	25	SINGLE
HYDROSTAR 300	835	295	430	25	SINGLE
HYDROSTAR 350	835	295	430	25	SINGLE
HYDROSTAR 200 3PH	835	295	430	25	SINGLE
HYDROSTAR 250 3 PH	835	295	430	25	SINGLE
HYDROSTAR 300 3PH	835	295	430	25	SINGLE
HYDROSTAR 350 3PH	835	295	430	25	SINGLE
HYDROSTAR 4003PH	835	295	430	25	SINGLE
HYDRTOSTAR 500 3PH	835	295	430	28	SINGLE
HYDROSTAR 600 3PH	835	295	430	30	SINGLE
HYDROSTAR 700 3PH	835	295	430	30	SINGLE

ACCESSORIES

1. Mac type barrel unions. Quantity (2).
2. Owners manual.
3. Warranty terms and conditions.

APPROVALS

The Hydrostar pump is approved to the following standards.

1. Australian standard **AS3136 & AS3350** (ref IEC 335).
2. **EN 60335-2-41** tested by **TUV Rheinland Product Safety**

WARRANTY

The Hydrostar pump comes with a comprehensive **2** year warranty from date of installation. Full warranty terms and conditions are supplied with each unit when sold.

PUMP PERFORMANCE

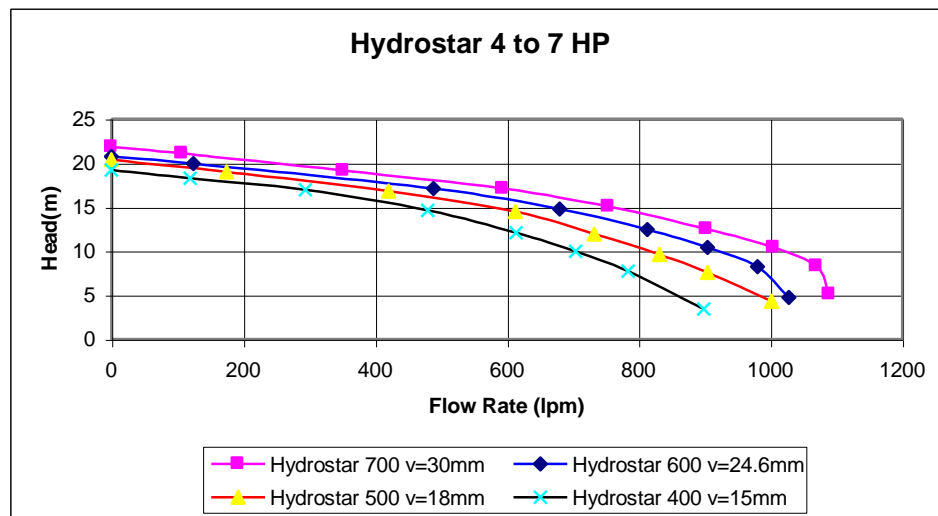
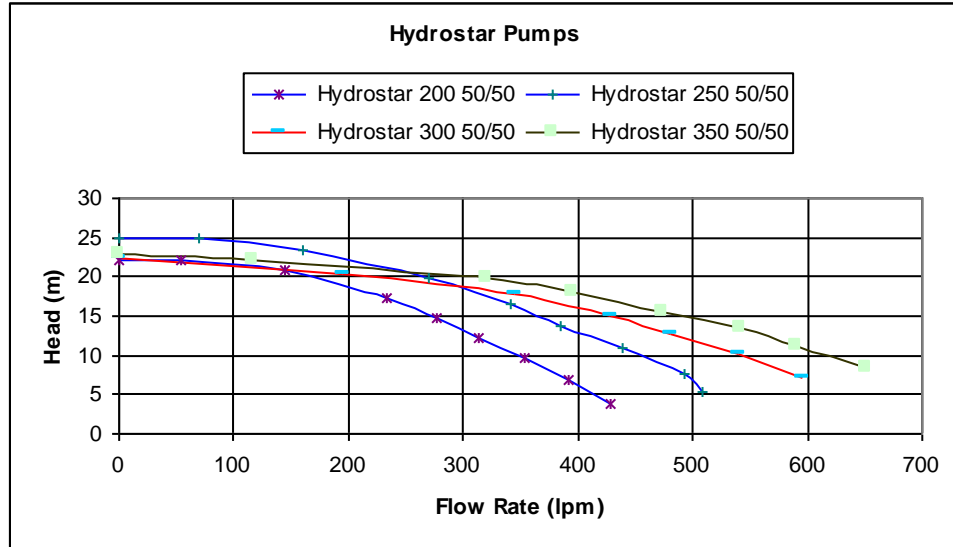

HYDROSTAR 200

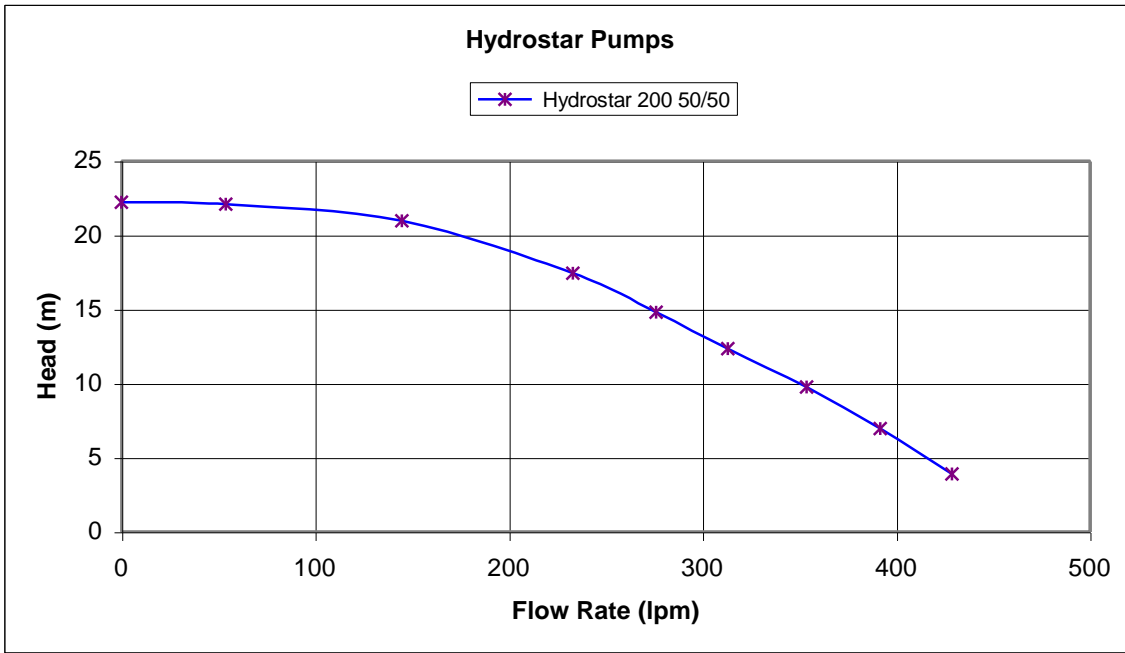

FLOW LPM	FLOW M3h	PRESSURE BAR	METERS
440	26.40	0.40	4.00
430	25.80	0.50	5.00
350	21.00	1.0	10.00
320	19.20	1.2	12.00
280	16.80	1.5	15.00
220	13.20	1.8	18.00
160	9.60	2.0	20.00
0	0.00	2.2	22.00

The maximum working pressure 22 meters. The maximum water temperature is 35 degrees Celsius.

HYDROSTAR 250

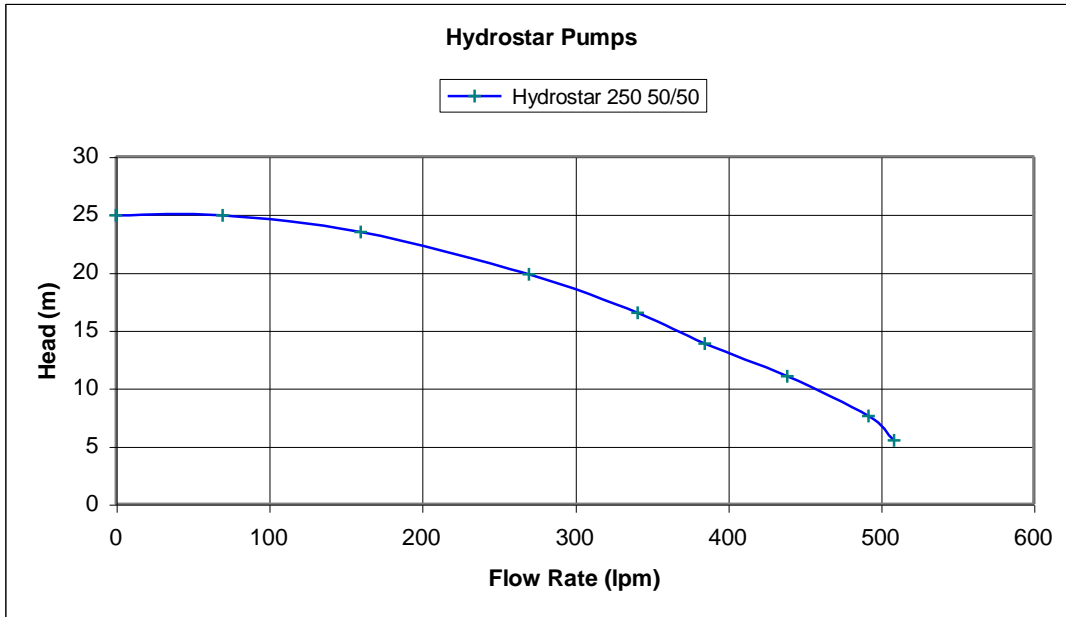

FLOW LPM	FLOW M3h	PRESSURE BAR	METERS
520	31.20	0.55	5.50
485	29.10	0.80	8.00
450	24.60	1.10	1.0
410	24.60	1.20	12.00
365	21.90	1.50	15.00
325	19.50	1.80	18.00
260	15.60	2.00	20.00
200	12.00	2.20	22.00
100	6.00	2.30	23.00
0	0	2.40	24.00

The maximum working pressure is 24 meters. Maximum water temperature is 35 degrees Celsius.

HYDROSTAR 300

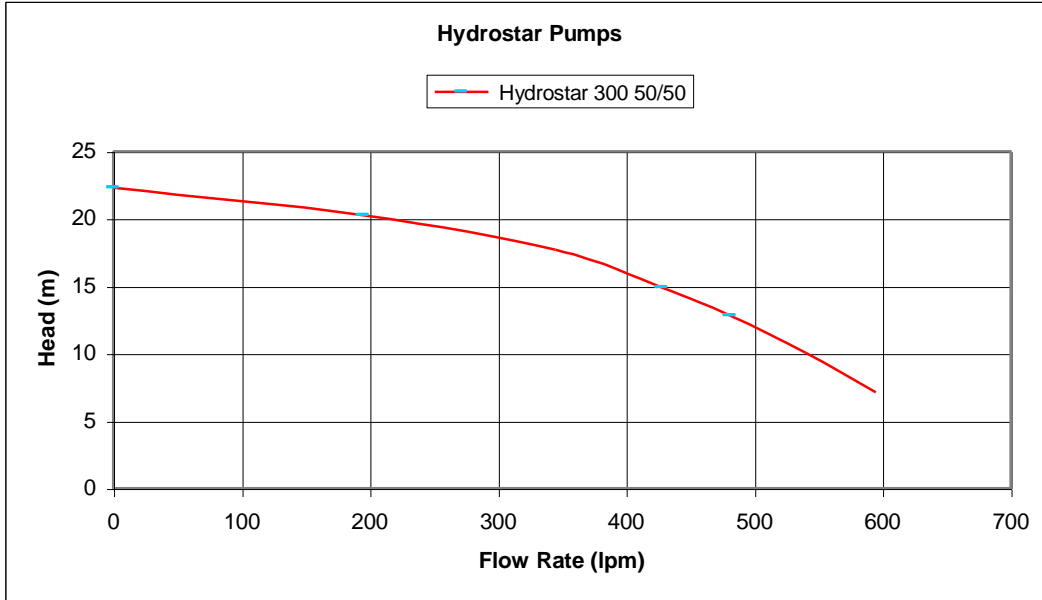

FLOW LPM	FLOW M3h	PRESSURE BAR	METERS
610	36.60	0.80	8.00
550	33.00	1.0	10.00
445	26.70	1.50	15.00
380	22.80	1.70	17.00
310	18.60	1.90	19.00
260	15.60	2.0	20.00
200	12.00	2.10	21.00
100	6.00	2.20	22.00
0	0	2.30	23.00

The maximum working pressure is 23 meters. Maximum water temperature is 35 degrees Celsius.

HYDROSTAR 350

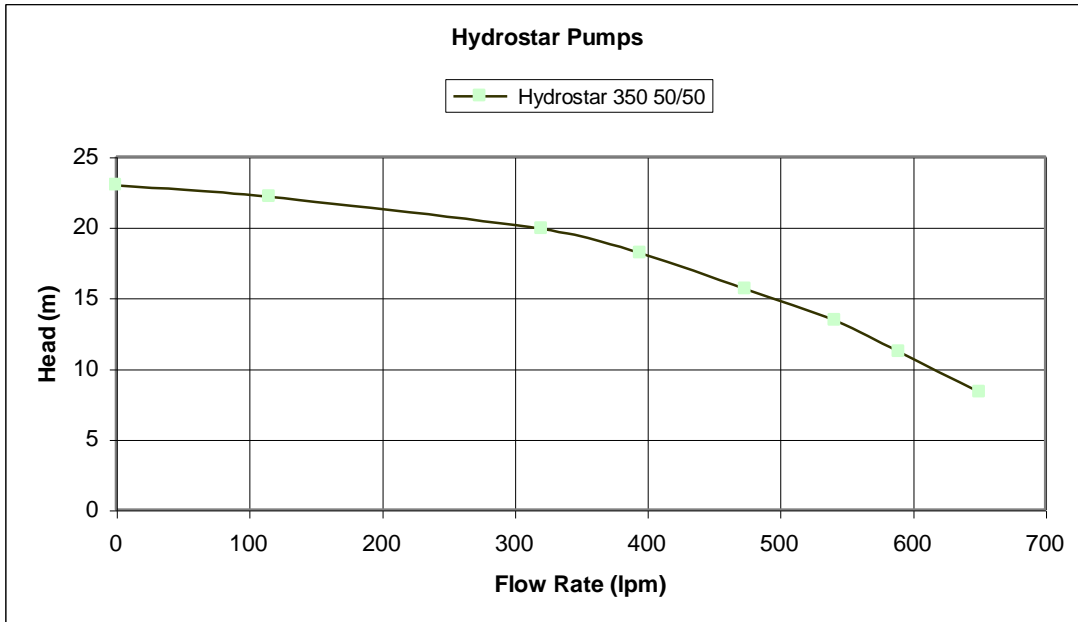

FLOW LPM	FLOW M3h	PRESSURE BAR	METERS
660	39.60	0.85	8.50
630	37.80	1.00	10.00
560	33.60	1.20	12.00
500	30.00	1.50	15.00
440	26.40	1.70	17.00
345	20.70	2.00	20.00
300	18.00	2.10	21.00
200	12.00	2.20	22.00
100	6.00	2.30	23.00
0	0	2.40	24.00

The maximum working pressure is 24 meters. Maximum water temperature is 35 degrees Celsius.

HYDROSTAR 400

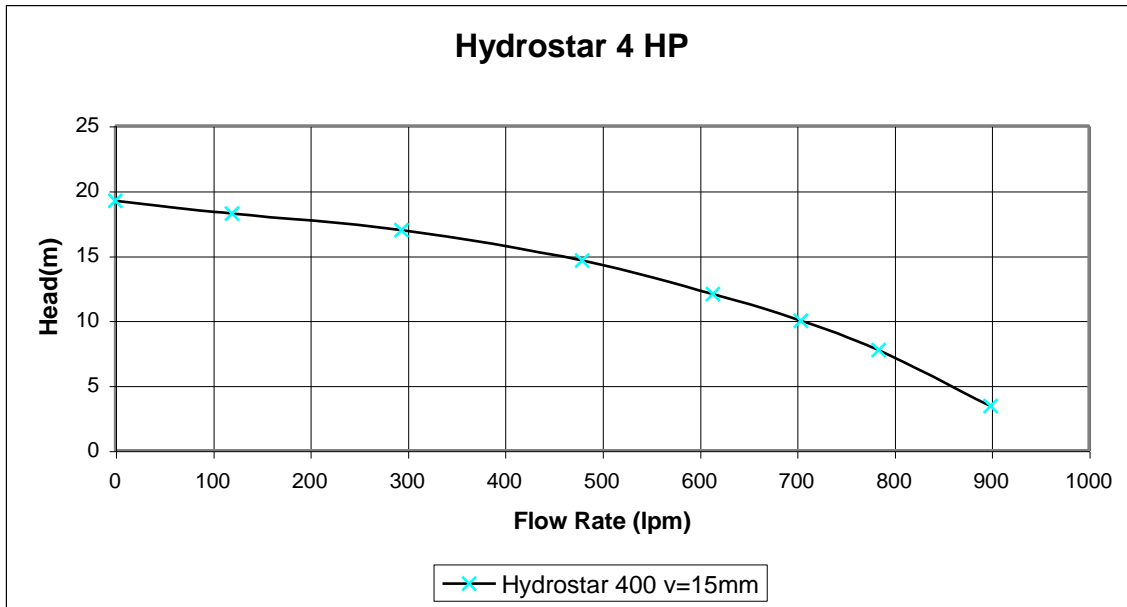

FLOW LPM	FLOW M3h	PRESSURE BAR	METERS
900	54.00	0.35	3.50
860	51.60	0.50	5.00
780	46.80	0.80	8.00
700	42.00	1.00	10.00
610	36.60	1.20	12.00
450	27.00	1.50	15.00
400	24.00	1.60	16.00
250	15.00	1.70	17.00
120	7.20	1.80	18.00
0	0	1.90	19.00

The maximum working pressure is 19 meters. Maximum water temperature is 35 degrees Celsius.

HYDROSTAR 500

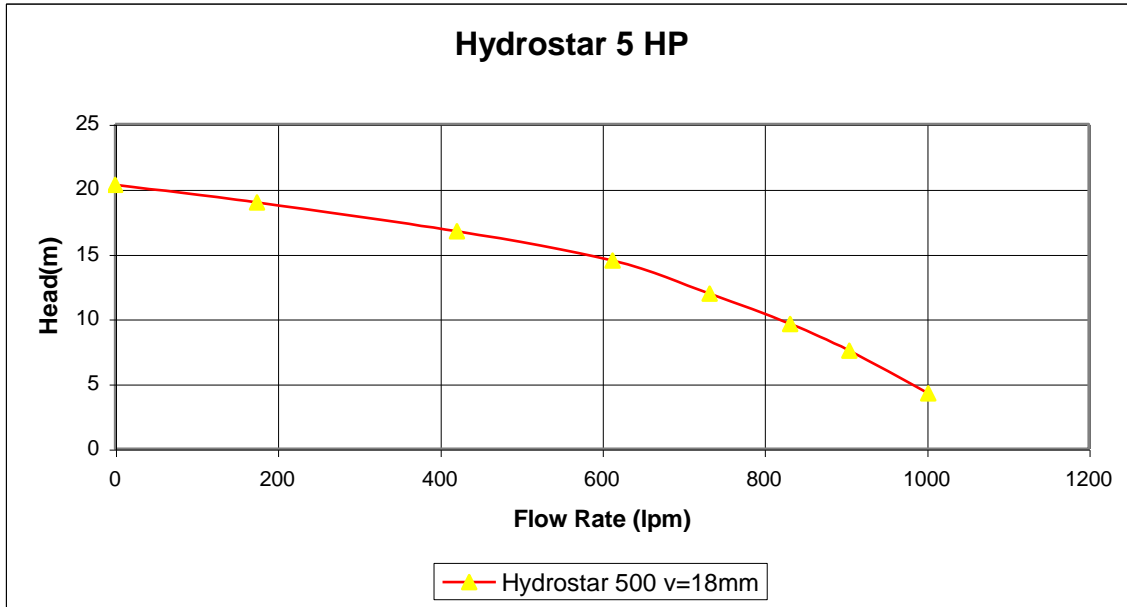

FLOW LPM	FLOW M3h	PRESSURE BAR	METERS
1000	60.00	0.45	4.50
900	54.00	0.80	8.00
810	48.60	1.00	10.00
720	43.20	1.20	12.00
600	36.00	1.50	15.00
400	24.00	1.60	16.00
300	18.00	1.70	17.00
200	12.00	1.80	18.00
0	0	2.10	21.00

The maximum working pressure is 21 meters. Maximum water temperature is 35 degrees Celsius.

HYDROSTAR 600

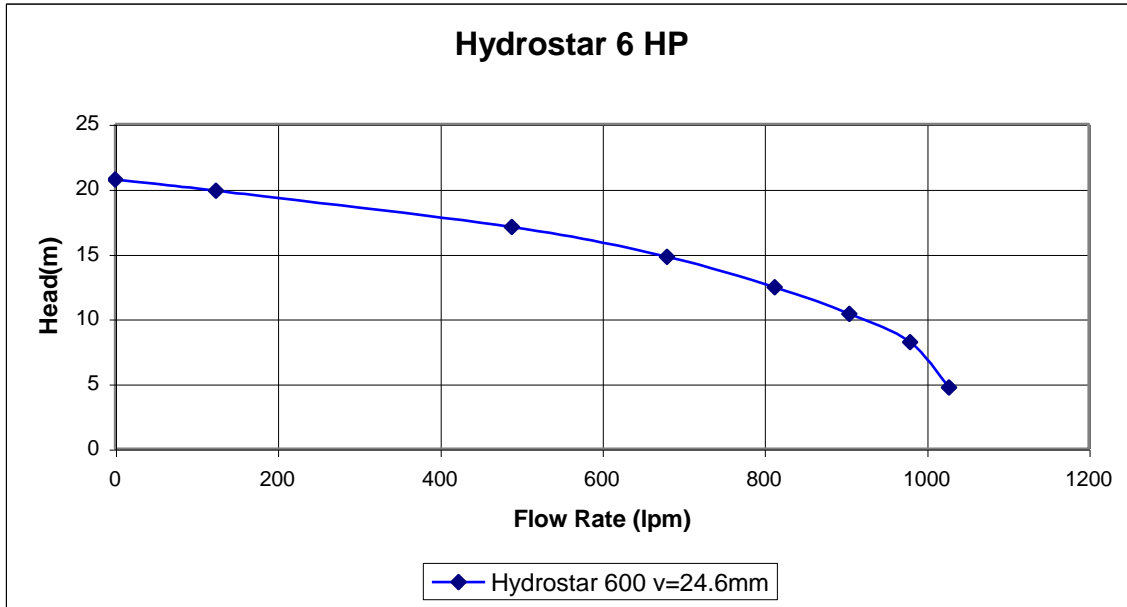

FLOW LPM	FLOW M3h	PRESSURE BAR	METERS
1025	61.50	0.50	5.00
980	58.80	0.80	8.00
920	55.20	1.00	10.00
800	48.00	1.20	12.00
660	39.60	1.50	15.00
480	28.80	1.80	18.00
200	12.00	1.90	19.00
130	7.80	2.00	20.00
0	0	2.20	22.00

The maximum working pressure 22 meters. Maximum water temperature is 35 degrees Celsius.

HYDROSTAR 700

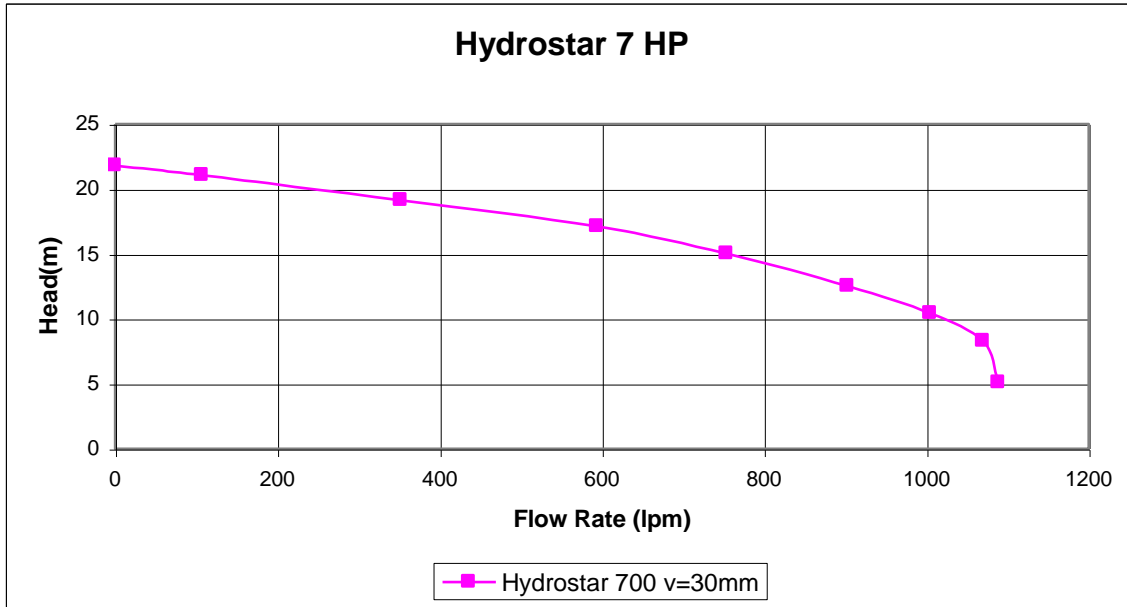

FLOW LPM	FLOW m3h	PRESSURE BAR	METERS
1100	66.00	0.50	5.00
1000	60.00	1.00	10.00
900	54.00	1.20	12.00
800	48.00	1.40	14.00
760	45.60	1.50	15.00
600	36.00	1.65	16.50
400	24.00	1.80	18.00
225	13.50	2.00	20.00
100	6.00	2.10	21.00
0	0	2.30	23.00

The maximum working pressure is 23 meters. Maximum water temperature is 35 degrees Celsius.

HYDROSTAR PARTS BREAKDOWN

PART NUMBER	PRODUCT DESCRIPTION	DIAGRAM NUMBER
6340276	MOTOR 2HP	1
6340276	MOTOR 2.5HP	1
634030	MOTOR 3.0HP	1
634030	MOTOR 3.5HP	1
6340276	MOTOR 2.0HP 3PH	1
6340276	MOTOR 2.5HP 3PH	1
634030	MOTOR 3.0HP 3PH	1
634030	MOTOR 3.50HP 3PH	1
63404040	MOTOR 4.0HP 3PH	1
6340403E	MOTOR 5.0HP 3PH	1
6340553E	MOTOR 6.0HP 3PH	1
6340553E	MOTOR 7.0HP 3PH	1
6340681	MOUNTING BRACKET	2
634070	MOUNTING BRACKET ORING	3
634016	MECHANICAL SEAL	4
634041	IMPELLER 2.0HP	5
634041	IMPELLER 2.50HP	5
634041	IMPELLER 3.0HP	5
634041	IMPELLER 3.5HP	5
634041	IMPELLER 4.0HP	5
634041	IMPELLER 5.0HP	5
634041	IMPELLER 6.0HP	5
634041	IMPELLER 7.0HP	5
634010	DIFFUSER	6
634011	DIFFUSER GASKET	7
63402531	SUCTION NOZZLE	8
6340661	LID & LOCK RING ASSY	9
634071	LID ORING	10
634063	HAIR & LINT BASKET	11
63406550	BARREL UNIONS	12
6340491	PUMP BODY ASSY	13
	PUMP FOOT ASSY	14

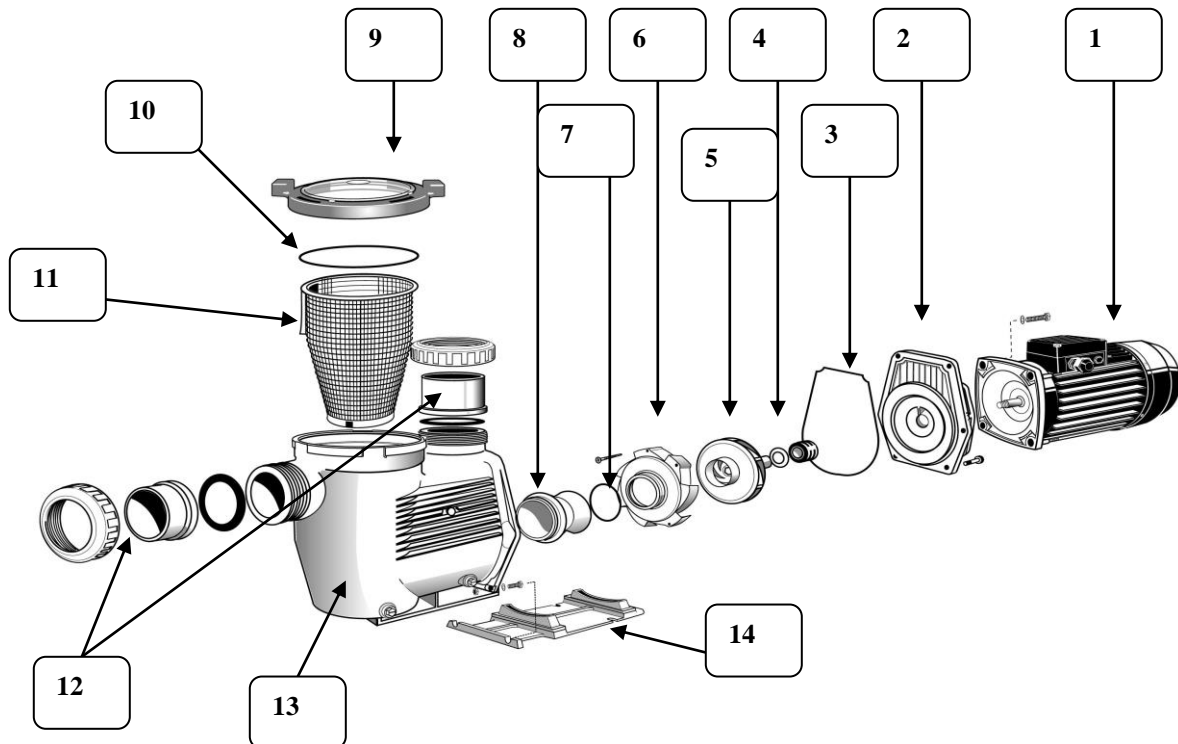

Hydrostar explo Feb02